

VITRINAS SEMIMURALES

LOW MULTIDECK DISPLAYS

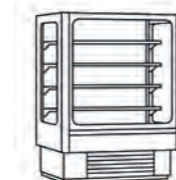

INSIGNIA - 171



SPECTRE - 193

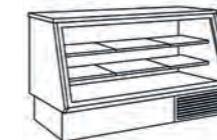

LUNNARIS - 211

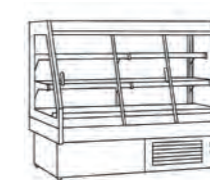

MAPLE - 217

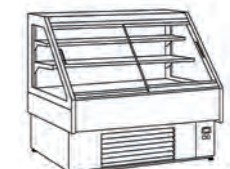

AZALEA - 227

INSIGNIA



La frescura y calidad merecen un escenario a la altura. Insignia transforma la exhibición en una experiencia visual cautivadora, donde cada producto resplandece con atractivo y autenticidad.

Freshness and quality deserve a stage to match. Insignia transforms the display into a captivating visual experience, where each product shines with appeal and authenticity.



OPCIONES DE PERSONALIZACIÓN • CUSTOMIZATION OPTIONS



OPCIÓN 1 • OPTION 1

Decoración total en colores sólidos RAL o NCS
(Sin incremento de precio)

Total decoration in solid colors RAL or NCS
(No price increase)



OPCIÓN 2 • OPTION 2

Decoración total en colores alto brillo
(Con incremento de precio)

Decoración en madera - Consultar

Full decoration in high-gloss colors
(Price increase)

Wood decoration - Consult

TIPOS DE REFRIGERACIÓN • TYPES OF REFRIGERATION

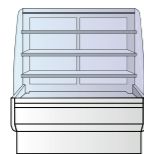

VV REFRIGERACIÓN
VV COOLING



VVB FRIO BOMBONES
VVB CHOCOLATES

OPCIONES DE CRISTALES - GLASS OPTIONS



VV-6-C: Cristal curvo, frontal cerrado
VV-6-C: Curved glass, closed front



VVA-6-C: Cristal curvo, frontal abierto
VVA-6-C: Curved glass, open front



VVAM-6-C: Cristal curvo, frontal abierto, respaldo mural
VVAM-6-C: Curved glass, open front, wall backrest



VV-6-R: Cristal recto, frontal cerrado (opcional puertas correderas)
VV-6-R: Straight glass, closed front (optional sliding doors)



VVA-6-R: Cristal recto, frontal abierto
VVA-6-R: Straight glass, self service front



VVAM-6-R: Cristal recto, frontal abierto, respaldo mural
VVAM-6-R: Straight glass, self service front, wall backrest

CARACTERÍSTICAS CONSTRUCTIVAS • CONSTRUCTION FEATURES

VV / VVA / VVAM

- Exterior en chapa de acero plastificada, lacada o inox.
- Interior en acero inoxidable AISI-304.
- Costados en ABS inyectado espesor 40 mm.
- Perfilería en aluminio anodizado.
- Aislamiento de poliuretano inyectado, densidad 40kg/m³, bajo GWP y cero efecto ODP.

- Exterior made of plastic-coated, lacquered or stainless steel sheet.
- Interior in AISI-304 stainless steel.
- Sides made of 40 mm thick injected ABS.
- Profiles made of anodized aluminum.
- Injected polyurethane insulation, density 40kg/m³, low GWP and zero ODP impact

VV-HE

- Cajón humidificador para aporte externo (solo VV)
- Control electrónico de temperatura
- Estantes de chapa de acero regulables
- VV-HE vitrina cerrada caliente (+60°+70°) y (45% - 50%RH)

- Humidifier drawer for external supply (VV only).
- Electronic temperature control.
- Adjustable steel sheet shelves.
- VV-HE: closed hot display case (+60° to +70°C) and (45% - 50% RH).

COMPONENTES • COMPONENTS

- Iluminación LED estándar: encimera y estantes.
- Evaporador tratado epoxi
- Condensación ventilada.
- Evaporador ventilado.
- Control electrónico de temperatura.
- Descarche automático con evaporación automática.
- Vidrio doble lateral, frontal, puerta y encimera
- Vidrio frontal doble, abatible.
- Estantes de vidrio securizado regulables (en altura).
- Puertas correderas traseras en aluminio negro RAL 9005, salvo modelo VV-6-6 (puerta abatible).
- VV-C: Modelo de vidrio curvo.
- VV-R: Modelo de vidrio recto
- VVA: Modelo autoservicio con cortina nocturna incluida.
- VVAM: Modelo autoservicio con respaldo mural. cortina nocturna incluida
- Chasis en acero acabado epoxy.
- Kits de unión: para instalaciones especiales y lineales. Consultar precio.
- Modelos preinstalación incorporan valvulería solenoide y expansión termostática en R-449A, opción R-134. Opcional otros refrigerantes.

- Standard LED lighting: on countertop and shelves.
- Epoxy-coated evaporator.
- Ventilated condensation.
- Ventilated evaporator.
- Electronic temperature control.
- Automatic defrost with automatic evaporation.
- Double glass on sides, front, door, and countertop.
- Tilting double front glass.
- Adjustable tempered glass shelves (height adjustable).
- Rear sliding doors in black aluminum RAL 9005, except model VV-6-6 (hinged door).
- VV-C: Model with curved glass.
- VV-R: Model with straight glass.
- VVA: Self-service model with included night curtain.
- VVAM: Self-service model with wall-back support and included night curtain.
- Epoxy-finished steel chassis.
- Joining kits: for special and linear installations. Ask for pricing.
- Pre-installation models include solenoid valves and thermostatic expansion valve for R-449A, R-134 option. Other refrigerants available upon request.

DATOS TÉCNICOS • TECHNICAL FEATURES

- Clase climática 3 (25°C 60%RH).
- VV: vitrina refrigerada para snack (+2°+8°).
- VVA: vitrina refrigerada autoservicio con cortina nocturna incluida (+2°+8°)
- VVB: vitrina refrigerada para chocolates (+14°+17°, 55% HR).
- Tensión de trabajo monofásica 220V 50Hz
- Tensión de trabajo monofásica 115V 60Hz o 220v 60Hz (consultar)

- Climate class 3 (25°C 60% RH).
- VV: refrigerated display case for snacks (+2° to +8°C).
- VVA: self-service refrigerated display case with included night curtain (+2° to +8°C).
- VVB: refrigerated display case for chocolates (+14° to +17°C, 55% RH).
- Operating voltage: single-phase 220V 50Hz.
- Operating voltage: single-phase 115V 60Hz or 220V 60Hz (upon request)

TIPOS DE ILUMINACIÓN • TYPES OF LIGHTING



4000K

ESTÁNDAR / STANDARD



3000K

RED FRESH

OPCIONAL / OPTIONAL

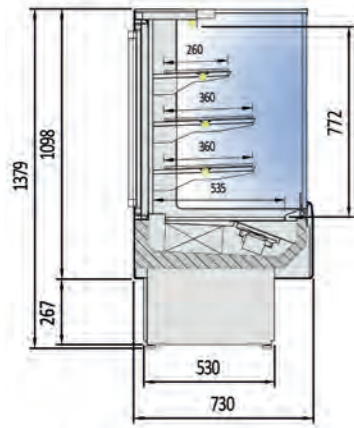

VV-6-R



Detalle puertas delanteras correderas
Detail of sliding front doors



Detalle apertura cristal y montaje estantes
Glass opening detail and mounting shelves



VV-6-16-R (RAL 5014)

Modelo Model	Largo Length	Área estantes refrigerados Refrigerated shelf area	Superficie total exposición (TDA) Total display area (TDA)	Volumen neto Net volume	Puertas correderas Sliding Doors	Potencia frig. Frig. Power HC	Consumo Nominal Nominal power HC	
	(mm)	(m²)	(m²)	(Lts.)	(Uds.)	(W)	(W)	
VV-6-6-R	600	0,74	0,55	140	1	483	837	3.451 €
VV-6-9-R	950	1,27	0,92	231	2	949	1140	4.188 €
VV-6-13-R	1300	1,78	1,29	322	2	949	1504	4.630 €
VV-6-16-R	1650	2,30	1,66	417	2	1528	1915	5.652 €



Clase Eficiencia Energética (Pag. 624)
Energy Efficiency Class (Pag. 624)

OPCIONALES · OPTIONS

Modelo Model	Decoración total alto brillo Black interior decoration	Decoración interior negro Black interior decoration	Puerta cristal corredera Sliding glass door	kit ruedas Castors kit
VV-6-6-R	215 €	164 €	-	240 €
VV-6-9-R	223 €	288 €	212 €	240 €
VV-6-13-R	230 €	372 €	294 €	240 €
VV-6-16-R	235 €	432 €	336 €	360 €

INSIGNIA VVB-R

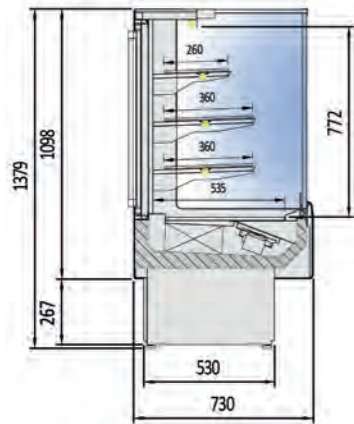

VVB-6-R



Detalle puertas delanteras correderas
Detail of sliding front doors



Detalle apertura cristal y montaje estantes
Glass opening detail and mounting shelves



VVB-6-g-R (Cuarzo)



Clase Eficiencia Energética (Pag. 624)
Energy Efficiency Class (Pag. 624)

Modelo Model	Largo Length	Área estantes refrigerados Refrigerated shelf area	Superficie total exposición (TDA) Total display area (TDA)	Volumen neto Net volume	Puertas correderas Sliding Doors	Potencia frig. Frig. Power HC	Consumo Nominal Nominal power HC	
	(mm)	(m²)	(m²)	(Lts.)	(Uds.)	(W)	(W)	
VVB-6-6-R	600	0.74	0.55	140	1	483	837	3.487 €
VVB-6-9-R	950	1.27	0.92	231	2	949	1140	4.230 €
VVB-6-13-R	1300	1.78	1.29	322	2	949	1501	4.675 €
VVB-6-16-R	1650	2.30	1.66	417	2	1528	1915	5.709 €

OPCIONALES · OPTIONS

Modelo Model	Decoración total alto brillo Black interior decoration	Decoración interior negro Black interior decoration	Puerta cristal corredera Sliding glass door	kit ruedas Castors kit
VVB-6-6-R	215 €	164 €	-	240 €
VVB-6-9-R	223 €	288 €	212 €	240 €
VVB-6-13-R	230 €	372 €	294 €	240 €
VVB-6-16-R	235 €	432 €	336 €	360 €

INSIGNIA VV-HE-R

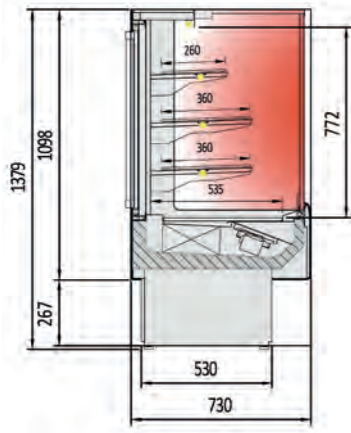

VV-6HE-R



Detalle cajon trasero humidificador (Disponible gama VV)
Detail rear humidifier drawer (VV range available)

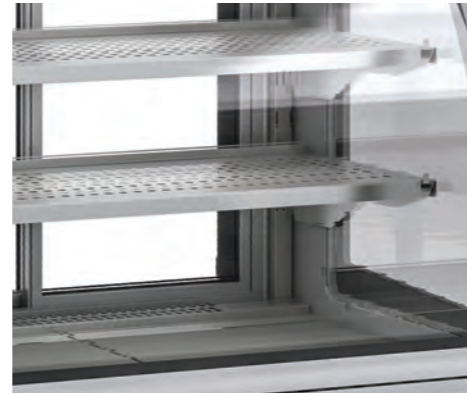

Detalle estantes de acero regulables
Detail stainless steel adjustable shelves



VV-6HE-13-R (Almirante)

Modelo Model	Largo Length	Área estantes calefactado Hot shelf area	Superficie total exposición (TDA) Total display area (TDA)	Volumen neto Net volume	Puertas correderas Sliding Doors	Consumo Nominal Nominal power HC	
	(mm)	(m²)	(m²)	(Lts.)	(Uds.)	(W)	
VV-6HE-6-R	600	0.74	0.55	140	1	1049	2.989 €
VV-6HE-9-R	950	1.27	0.92	231	2	1683	3.658 €
VV-6HE-13-R	1300	1.78	1.29	322	2	2517	4.083 €
VV-6HE-16-R	1650	2.30	1.66	417	2	3351	4.987 €

OPCIONALES · OPTIONS

Modelo Model	Decoración total alto brillo Black interior decoration	Decoración interior negro Black interior decoration	Puerta cristal corredera Sliding glass door	kit ruedas Castors kit
VV-6HE-6-R	215 €	164 €	-	240 €
VV-6HE-9-R	223 €	288 €	212 €	240 €
VV-6HE-13-R	230 €	372 €	294 €	240 €
VV-6HE-16-R	235 €	432 €	336 €	360 €

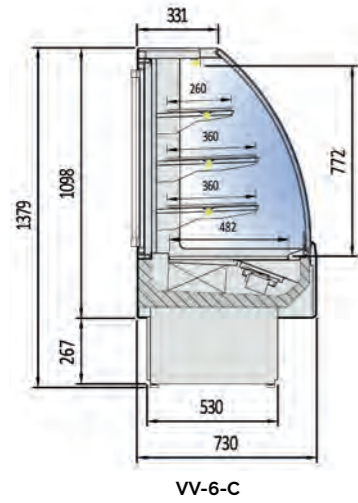

Detalle puertas traseras correderas
Detail of sliding rear doors







Detalle apertura cristal y montaje estantes
Glass opening detail and mounting shelves



VV-6-6-C (Silex)



Clase Eficiencia Energética (Pag. 624)
Energy Efficiency Class (Pag. 624)

Modelo Model	Largo Length	Área estantes refrigerados Refrigerated shelf area	Superficie total exposición (TDA) Total display area (TDA)	Volumen neto Net volume	Puertas correderas Sliding Doors	Potencia frig. Frig. Power HC	Consumo Nominal Nominal power HC	
	(mm)	(m²)	(m²)	(Lts.)	(Uds.)	(W)	(W)	
 VV-6-6-C	600	0,74	0,55	140	1	483	837	3.471 €
 VV-6-9-C	950	1,27	0,92	231	2	949	1140	4.197 €
 VV-6-13-C	1300	1,78	1,29	322	2	949	1504	4.633 €
 VV-6-16-C	1650	2,30	1,66	417	2	1528	1915	5.678 €

OPCIONALES · OPTIONS

Modelo Model	Decoración total alto brillo Black interior decoration	Decoración interior negro Black interior decoration	kit ruedas Castors kit
VV-6-6-C	215 €	164 €	240 €
VV-6-9-C	223 €	288 €	240 €
VV-6-13-C	230 €	372 €	240 €
VV-6-16-C	235 €	432 €	360 €

INSIGNIA VVB-C

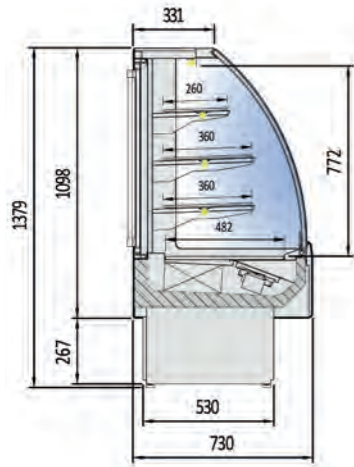

VVB-6-C







Detalle puertas traseras correderas
Detail of sliding rear doors



Detalle apertura cristal y montaje estantes
Glass opening detail and mounting shelves



VVB-6-13-C (Rosa Cuarzo)

Modelo Model	Largo Length	Área estantes refrigerados Refrigerated shelf area	Superficie total exposición (TDA) Total display area (TDA)	Volumen neto Net volume	Puertas correderas Sliding Doors	Potencia frig. Frig. Power HC	Consumo Nominal Nominal power HC	
	(mm)	(m²)	(m²)	(Lts.)	(Uds.)	(W)	(W)	
 VVB-6-6-C	600	0,74	0,55	140	1	483	837	3.506 €
 VVB-6-9-C	950	1,27	0,92	231	2	949	1140	4.238 €
 VVB-6-13-C	1300	1,78	1,29	322	2	949	1501	4.679 €
 VVB-6-16-C	1650	2,30	1,66	417	2	1528	1915	5.735 €

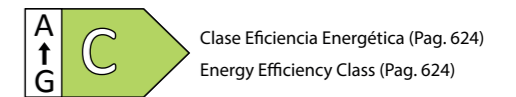

Clase Eficiencia Energética (Pag. 624)
Energy Efficiency Class (Pag. 624)

OPCIONALES · OPTIONS

Modelo Model	Decoración total alto brillo Black interior decoration	Decoración interior negro Black interior decoration	kit ruedas Castors kit
VVB-6-6-C	215 €	164 €	240 €
VVB-6-9-C	223 €	288 €	240 €
VVB-6-13-C	230 €	372 €	240 €
VVB-6-16-C	235 €	432 €	360 €

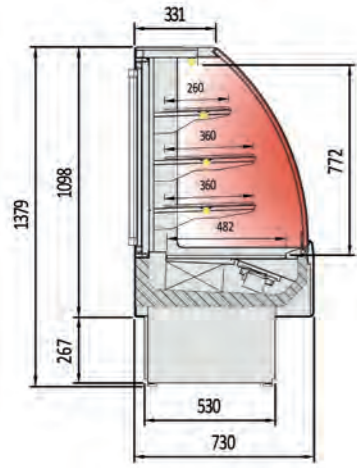

VV-6HE-C



Detalle cajon trasero humidificador (Disponible gama VV y VVA)
Detail rear humidifier drawer (VV and VVA range available)

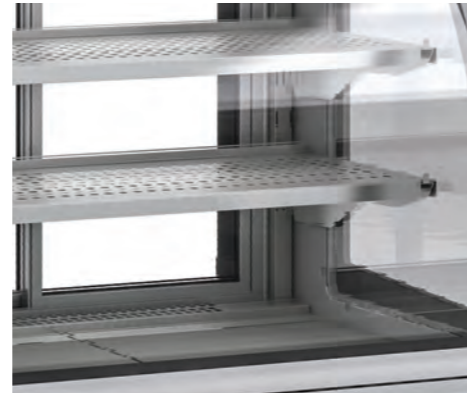

Detalle estantes de acero regulables
Detail stainless steel adjustable shelves





INSIGNIA VV-HE-C

docriluc

SEMIMURALES



VV-6HE-9-C (Negro)

Modelo Model	Largo Length	Área estantes calefactado Hot shelf area	Superficie total exposición (TDA) Total display area (TDA)	Volumen neto Net volume	Puertas correderas Sliding Doors	Consumo Nominal Nominal power HC	
	(mm)	(m²)	(m²)	(Lts.)	(Uds.)	(W)	
 VV-6HE-6-C	600	0.74	0.55	140	1	1049	3.087 €
 VV-6HE-9-C	950	1.27	0.92	231	2	1683	3.804 €
 VV-6HE-13-C	1300	1.78	1.29	322	2	2517	4.203 €
 VV-6HE-16-C	1650	2.30	1.66	417	2	3351	5.033 €

OPCIONALES · OPTIONS

Modelo Model	Decoración total alto brillo Black interior decoration	Decoración interior negro Black interior decoration	kit ruedas Castors kit
VV-6HE-6-C	215 €	164 €	240 €
VV-6HE-9-C	223 €	288 €	240 €
VV-6HE-13-C	230 €	372 €	240 €
VV-6HE-16-C	235 €	432 €	360 €

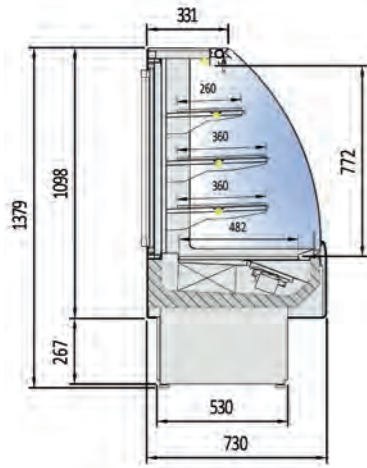

VVA-6-C

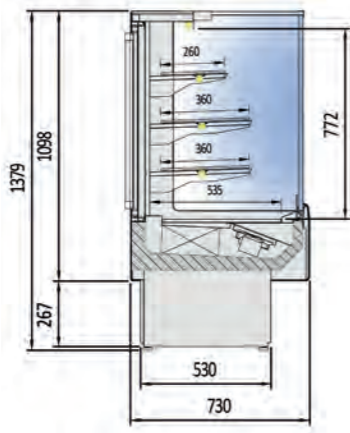



VVA-6-R



Detalle interior VV
Interior detail VV



VVA-6-13-C (Arcilla)

Modelo Model	Largo Length (mm)	Área estantes refrigerados Refrigerated shelf area (m²)	Superficie total exposición (TDA) Total display area (TDA) (m²)	Volumen neto Net volume (Lts.)	Puertas corre- deras Sliding Doors (Uds.)	Potencia frig. Frig. Power HC (W)	Consumo Nominal Nominal power HC (W)	
 VVA-6-6-C/R	600	0,74	0,62	140	1	483	1137	3.526 €
 VVA-6-9-C/R	950	1,27	1,03	231	2	949	1380	4.102 €
 VVA-6-13-C/R	1300	1,78	1,44	322	2	1419	1670	4.546 €

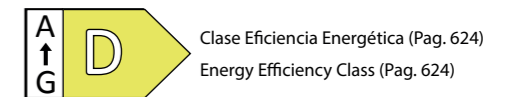

Clase Eficiencia Energética (Pag. 624)
Energy Efficiency Class (Pag. 624)

OPCIONALES · OPTIONS

Modelo Model	Decoración total alto brillo Black interior decoration	Decoración interior negro Black interior decoration	kit ruedas Castors kit
VVA-6-6-C	215 €	164 €	240 €
VVA-6-9-C	223 €	288 €	240 €
VVA-6-13-C	230 €	372 €	240 €

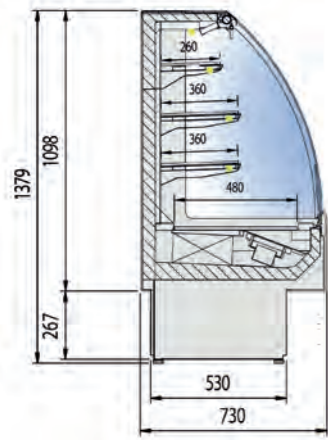



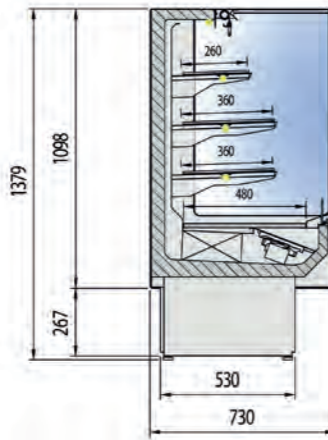

VVAM-6-C



VVAM-6-R



VVAM-6-16 (RAL-260 80 15)
Tipo mural - Wallback type

Modelo Model	Largo Length (mm)	Área estantes refrigerados Refrigerated shelf area (m²)	Superficie total exposición (TDA) Total display area (m²)	Volumen neto Net volume (Lts.)	Puertas correderas Sliding Doors (Uds.)	Potencia fríg. Frig. Power HC (W)	Consumo Nominal Nominal power HC (W)	
 VVAM-6-6	600	0,66	0,62	128	0	483	1137	3.130 €
 VVAM-6-9	950	1,13	1,03	209	0	949	1380	3.705 €
 VVAM-6-13	1300	1,58	1,44	293	0	1419	1670	4.040 €
 VVAM-6-16	1650	2,05	1,85	379	0	1931	2084	5.361 €

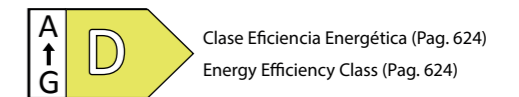

Clase Eficiencia Energética (Pag. 624)
Energy Efficiency Class (Pag. 624)

OPCIONALES · OPTIONS

Modelo Model	Decoración total alto brillo Black interior decoration	Decoración interior negro Black interior decoration	Puerta cristal corredera Sliding glass door	kit ruedas Castors kit
VVAM-6-6-R	215 €	188 €	-	240 €
VVAM-6-9-R	223 €	300 €	212 €	240 €
VVAM-6-13-R	230 €	385 €	294 €	240 €
VVAM-6-16-R	235 €	444 €	336 €	360 €

SPECTRE

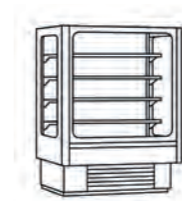

Presencia sutil pero imponente, Spectre envuelve los alimentos en un aura de pureza y conservación óptima. Un espacio donde cada ingrediente revela su mejor versión.

With a subtle yet imposing presence, Spectre envelops food in an aura of purity and optimal preservation. A space where each ingredient reveals its best.

OPCIONES DE PERSONALIZACIÓN • CUSTOMIZATION OPTIONS



OPCIÓN 1 • OPTION 1

Decoración total en colores sólidos RAL o NCS
(Sin incremento de precio)

Total decoration in solid colors RAL or NCS
(No price increase)



OPCIÓN 2 • OPTION 2

Decoración total en colores alto brillo
(Con incremento de precio)

Decoración en madera - Consultar

Full decoration in high-gloss colors
(Price increase)

Wood decoration - Consult

TIPOS DE REFRIGERACIÓN • TYPES OF REFRIGERATION

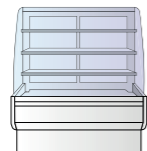

VV REFRIGERACIÓN
VV COOLING

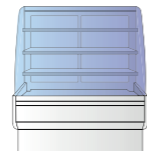

VVB FRIO BOMBONES
VVB CHOCOLATES

OPCIONES DE CRISTALES - GLASS OPTIONS

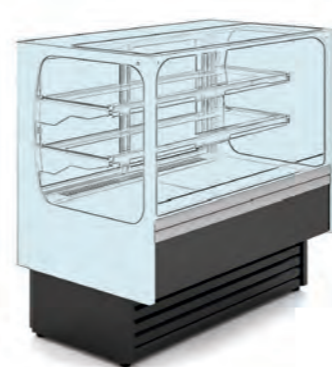

VVA-6-MR: Cristal inclinado frontal abierto
VVA-6-MR: Inclined straight glass, open front

VVAM-6-MR: Cristal inclinado, frontal abierto, respaldo mural
VVAM-6-MR: Inclined straight glass, open front, wall backrest

VV-6-RGB: Cristal panorámico recto, 1 estante alt. 1.100mm
VV-6-RGB: Panoramic straight glass, 1 shelf ht. 1.100 mm

VV-6-RGM: Cristal panorámico recto, 2 estantes alt. 1.195mm
VV-6-RGM: Panoramic straight glass, 2 shelves ht. 1.195 mm

VV-6-RG: Cristal panorámico recto, 3 estantes alt. 1.380mm
VV-6-RG: Panoramic straight glass, 3 shelves ht. 1.380 mm

CARACTERÍSTICAS CONSTRUCTIVAS • CONSTRUCTION FEATURES

VV-RG/RGM/RGB / VV-MR / VVA-MR / VVAM-MR

- Exterior fabricado en chapa de acero plastificada, lacada o inox.
- Costados panorámicos vidrio doble, serigrafiados en negro RAL 9005.
- Interior en acero inoxidable AISI-304.
- Perfilería en aluminio anodizado.
- Aislamiento de poliuretano inyectado, densidad 40kg/m3, bajo GWP y cero efecto ODP.

- Clase climática 3 (25°C 60%RH).
- VV-RG / MR: vitrina refrigerada para snack (+2°+8°).
- VVA-MR: vitrina refrigerada autoservicio con cortina nocturna incluida (+2°+8°)
- VVB-RG: vitrina refrigerada para chocolates (+14°+17°, 55% HR).
- Tensión de trabajo monofásica 220V 50Hz
- Tensión de trabajo monofásica 115V 60Hz o 220v 60Hz (consultar)

VVAM-HE

- Control electrónico de temperatura
- Estantes de chapa de acero regulables
- VV-HE vitrina cerrada caliente (+60°+70°) y (45% - 50%RH)

- Electronic temperature control.
- Adjustable steel sheet shelves.
- VV-HE: closed hot display case (+60°C to +70°C, 45% - 50% RH).

COMPONENTES • COMPONENTS

- Iluminación LED estándar: encimera y estantes.
- Evaporador tratado epoxi
- Condensación ventilada.
- Evaporador ventilado.
- Control electrónico de temperatura.
- Descarche automático con evaporación automática.
- Vidrio doble, frontal, puerta y encimera
- Vidrio frontal doble, abatible.
- Estantes de vidrio securizado regulables (en altura),
- Puertas correderas traseras en aluminio negro RAL 9005, salvo modelo VV-6-6 (puerta abatible).
- VV-RG: Modelo vidrio panorámico. Disponible en tres alturas.
- RGB: H 1100mm
- RGM: H 1195mm
- RG: H 1380mm
- VV-MR: Modelo vidrio panorámico inclinado.
- VVA-MR: Modelo autoservicio con cortina nocturna incluida.
- VVAM-MR: Modelo autoservicio con respaldo mural, cortina nocturna incluida
- Chasis en acero acabado epoxy.
- Kits de unión: para instalaciones especiales y lineales. Consultar precio.
- Modelos preinstalación incorporan valvulería solenoide y expansión termostática en R-449A, opción

- Standard LED lighting: on countertop and shelves.
- Epoxy-coated evaporator.
- Ventilated condensation.
- Ventilated evaporator.
- Electronic temperature control.
- Automatic defrost with automatic evaporation.
- Double glass on front, doors, and countertop.
- Tilting double front glass.
- Adjustable tempered glass shelves (height adjustable).
- Rear sliding doors in black aluminum RAL 9005, except model VV-6-6 (hinged door).
- VV-RG: Panoramic glass model. Available in three heights:
- a) RGB: H 1100 mm
- b) RGM: H 1195 mm
- c) RG: H 1380 mm
- VV-MR: Inclined panoramic glass model.
- VVA-MR: Self-service model with included night curtain.
- VVAM-MR: Self-service model with wall-back support and included night curtain.
- Chassis in epoxy-coated steel.
- Joining kits: for special and linear installations. Ask for pricing.
- Pre-installation models include solenoid valve and thermostatic expansion valve for R-449A, with R-134 option available.

DATOS TÉCNICOS • TECHNICAL FEATURES

- Clase climática 3 (25°C 60%RH).
- VV-RG / MR: vitrina refrigerada para snack (+2°+8°).
- VVA-MR: vitrina refrigerada autoservicio con cortina nocturna incluida (+2°+8°)
- VVB-RG: vitrina refrigerada para chocolates (+14°+17°, 55% HR).
- Tensión de trabajo monofásica 220V 50Hz
- Tensión de trabajo monofásica 115V 60Hz o 220v 60Hz (consultar)

- Climate class 3 (25°C, 60% RH).
- VV-RG / MR: refrigerated display case for snacks (+2°C to +8°C).
- VVA-MR: self-service refrigerated display case with included night curtain (+2°C to +8°C).
- VVB-RG: refrigerated display case for chocolates (+14°C to +17°C, 55% RH).
- Operating voltage: single-phase 220V 50Hz.
- Operating voltage: single-phase 115V 60Hz or 220V 60Hz (upon request).

TIPOS DE ILUMINACIÓN • TYPES OF LIGHTING



4000K

ESTÁNDAR / STANDARD



3000K

RED FRESH

OPCIONAL / OPTIONAL

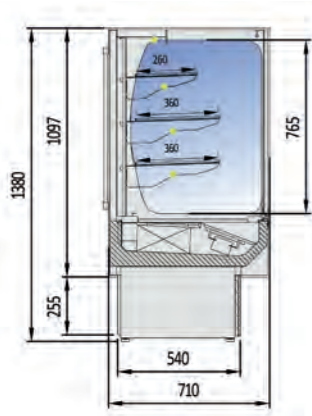





VV-6-RG



Detalle puertas traseras correderas
Detail of sliding rear doors



VV-6-9-RG (Gris Urban)

Modelo Model	Largo Length	Área estantes refrigerados Refrigerated shelf area	Superficie total exposición (TDA) Total display area (TDA)	Volumen neto Net volume	Puertas correderas Sliding Doors	Potencia frig. Frig. Power HC	Consumo Nominal Nominal power HC	
	(mm)	(m²)	(m²)	(Lts.)	(Uds.)	(W)	(W)	
 VV-6-6-RG	600	0,74	0,55	140	1	483	1137	3.693 €
 VV-6-9-RG	950	1,27	0,92	231	2	949	1380	4.483 €
 VV-6-13-RG	1300	1,78	1,29	322	2	1419	1670	5.033 €
 VV-6-16-RG	1650	2,30	1,66	417	2	1931	2084	6.116 €



Tu elección rápida, en stock, siempre listo
 Disponible en decoración exterior color negro
 Your quick choice, always in stock, always ready
 Available in black exterior finish



Clase Eficiencia Energética (Pag. 624)
 Energy Efficiency Class (Pag. 624)

OPCIONALES · OPTIONS



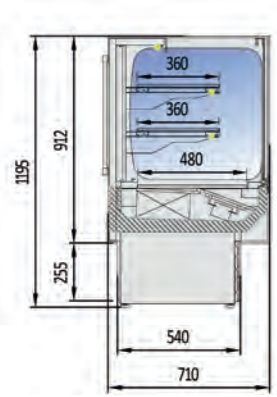

Modelo Model	Decoración total alto brillo Black interior decoration	Decoración interior negro Black interior decoration	Puerta cristal corredera Sliding glass door	kit ruedas Castors kit
VV-6-6-RG	215 €	164 €	-	240 €
VV-6-9-RG	223 €	288 €	212 €	240 €
VV-6-13-RG	230 €	372 €	294 €	240 €
VV-6-16-RG	235 €	432 €	336 €	360 €



VV-6-RGM



VV-6-13-RGM (Menta)

Modelo Model	Largo Length	Área estantes refrigerados Refrigerated shelf area	Superficie total exposición (TDA) Total display area (TDA)	Volumen neto Net volume	Puertas correderas Sliding Doors	Potencia frig. Frig. Power HC	Consumo Nominal Nominal power HC	
	(mm)	(m²)	(m²)	(Lts.)	(Uds.)	(W)	(W)	
 VV-6-6-RGM	600	0.60	0.50	120	1	483	1137	3.624 €
 VV-6-9-RGM	950	1.03	0.86	197	2	949	1380	4.390 €
 VV-6-13-RGM	1300	1.44	1.20	272	2	1419	1670	4.989 €
 VV-6-16-RGM	1650	1.87	1.56	354	2	1931	2084	6.029 €

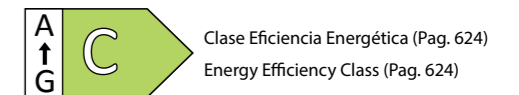

Clase Eficiencia Energética (Pag. 624)
Energy Efficiency Class (Pag. 624)

OPCIONALES · OPTIONS

Modelo Model	Decoración total alto brillo Black interior decoration	Decoración interior negro Black interior decoration	Puerta cristal corredera Sliding glass door	kit ruedas Castors kit
VV-6-6-RGM	215 €	164 €	-	240 €
VV-6-9-RGM	223 €	288 €	212 €	240 €
VV-6-13-RGM	230 €	372 €	294 €	240 €
VV-6-16-RGM	235 €	432 €	336 €	360 €

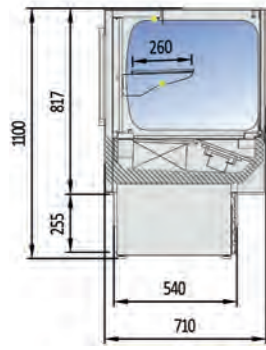





VV-6-RGB



Detalle modelo VV-RGB encastrada
Detail model VV-RGB recessed



VV-6-9-RGB (Sillex)

Modelo Model	Largo Length	Área estantes refrigerados Refrigerated shelf area	Superficie total exposición (TDA) Total display area (TDA)	Volumen neto Net volume	Puertas correderas Sliding Doors	Potencia frig. Frig. Power HC	Consumo Nominal Nominal power HC	
	(mm)	(m²)	(m²)	(Lts.)	(Uds.)	(W)	(W)	
 VV-6-6-RGB	0,37	0,46	85	1	483	1137	1137	3.567 €
 VV-6-9-RGB	0,63	0,79	135	2	949	1380	1380	4.358 €
 VV-6-13-RGB	0,89	1,11	185	2	1419	1670	1670	4.912 €
 VV-6-16-RGB	1,15	1,44	238	2	1931	2084	2084	5.986 €



Clase Eficiencia Energética (Pag. 624)
Energy Efficiency Class (Pag. 624)

OPCIONALES · OPTIONS

Modelo Model	Decoración total alto brillo Black interior decoration	Decoración interior negro Black interior decoration	Puerta cristal corredera Sliding glass door	kit ruedas Castors kit
VV-6-6-RGB	215 €	164 €	-	240 €
VV-6-9-RGB	223 €	288 €	212 €	240 €
VV-6-13-RGB	230 €	372 €	294 €	240 €
VV-6-16-RGB	235 €	432 €	336 €	360 €

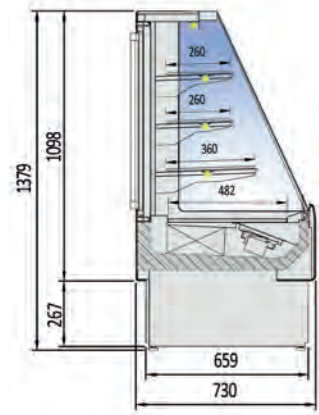

VV-6-MR



VV-6-g-MR (Perla)

Modelo	Largo	Área estantes refrigerados	Superficie total exposición (TDA)	Volumen neto	Puertas correderas	Potencia frig.	Consumo Nominal	
Model	Length	Refrigerated shelf area	Total display area (TDA)	Net volume	Sliding Doors	Frig. Power HC	Nominal power HC	
	(mm)	(m²)	(m²)	(Lts.)	(Uds.)	(W)	(W)	
VV-6-6-MR	560	0.68	0.55	101	1	483	837	3.520 €
VV-6-9-MR	910	1.15	0.92	166	2	949	1140	4.230 €
VV-6-13-MR	1260	1.63	1.29	239	2	949	1501	4.722 €
VV-6-16-MR	1610	2.09	1.66	301	2	1528	1915	5.843 €



Clase Eficiencia Energética (Pag. 624)
Energy Efficiency Class (Pag. 624)

OPCIONALES · OPTIONS

Modelo	Decoración total alto brillo	Decoración interior negro	kit ruedas
Model	Black interior decoration	Black interior decoration	Castors kit
VV-6-6-MR	215 €	164 €	240 €
VV-6-9-MR	223 €	288 €	240 €
VV-6-13-MR	230 €	372 €	240 €
VV-6-16-MR	235 €	432 €	360 €

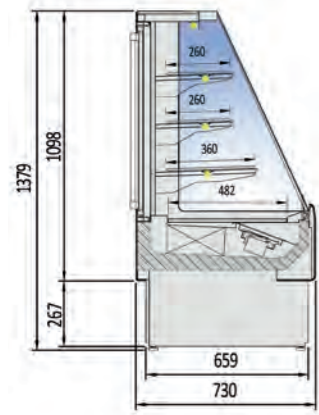



VVA-6-MR



Detalle interior VV
Interior detail VV



VVA-6-g-MR (Luna)

Modelo Model	Largo Length (mm)	Área estantes refrigerados Refrigerated shelf area (m²)	Superficie total exposición (TDA) Total display area (TDA) (m²)	Volumen neto Net volume (Lts.)	Puertas correderas Sliding Doors (Uds.)	Potencia frig. Frig. Power HC (W)	Consumo Nominal Nominal power HC (W)	
 VVA-6-6-MR	560	0,68	0,62	101	1	483	1137	3.595 €
 VVA-6-9-MR	910	1,15	1,03	166	2	949	1380	4.142 €
 VVA-6-13-MR	1260	1,63	1,44	239	2	1419	1670	4.659 €

A
↑
G **D** Clase Eficiencia Energética (Pag. 624)
Energy Efficiency Class (Pag. 624)

OPCIONALES · OPTIONS



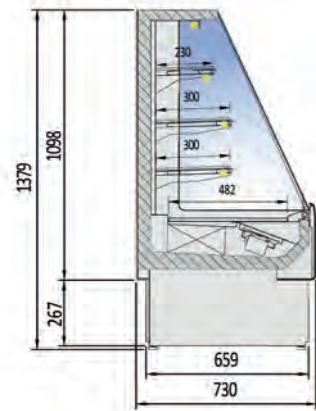

Modelo Model	Decoración total alto brillo Black interior decoration	Decoración interior negro Black interior decoration	kit ruedas Castors kit
VVA-6-6-MR	215 €	164 €	240 €
VVA-6-9-MR	223 €	288 €	240 €
VVA-6-13-MR	230 €	372 €	240 €



VVAM-6-MR



VVAM-6-13-MR (Inox)

Modelo	Largo	Área estantes refrigerados	Superficie total exposición (TDA)	Volumen neto	Puertas correderas	Potencia frig.	Consumo Nominal	
Model	Length	Refrigerated shelf area	Total display area (TDA)	Net volume	Sliding Doors	Frig. Power HC	Nominal power HC	
	(mm)	(m²)	(m²)	(Lts.)	(Uds.)	(W)	(W)	
 VVAM-6-6-MR	560	0.62	0.62	93	0	483	1137	3.474 €
 VVAM-6-9-MR	910	1.06	1.03	151	0	949	1380	3.905 €
 VVAM-6-13-MR	1260	1.5	1.44	211	0	1419	1670	4.434 €
 VVAM-6-16-MR	1610	1.94	1.85	273	0	1931	2084	5.680 €

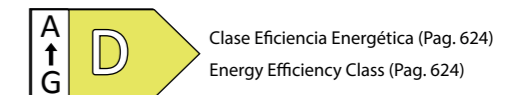

Clase Eficiencia Energética (Pag. 624)
Energy Efficiency Class (Pag. 624)

OPCIONALES · OPTIONS

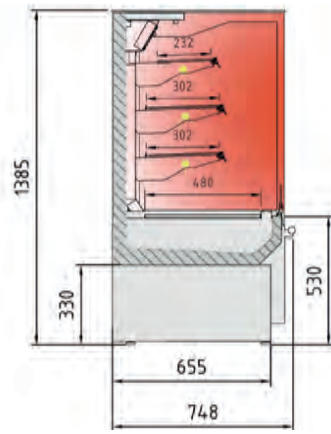

Modelo	Decoración total alto brillo	Decoración interior negro	kit ruedas
Model	Black interior decoration	Black interior decoration	Castors kit
VVAM-6-6-MR	215 €	188 €	240 €
VVAM-6-9-MR	223 €	300 €	240 €
VVAM-6-13-MR	230 €	385 €	240 €
VVAM-6-16-MR	235 €	444 €	360 €



VVAM-6HE



VVAM-6HE-9 (Negro)

Modelo Model	Largo Length	Área estantes calefactado Hot shelf area	Superficie total exposición (TDA) Total display area (TDA)	Volumen neto Net volume	Puertas correderas Sliding Doors	Consumo Nominal Nominal power HC	
	(mm)	(m²)	(m²)	(Lts.)	(Uds.)	(W)	
 VVAM-6HE-9	915	1.27	0.92	189	-	1683	3.731 €
 VVAM-6HE-13	1265	1.78	1.29	280	-	2430	4.225 €

OPCIONALES · OPTIONS

Modelo Model	Decoración total alto brillo Black interior decoration	Decoración interior negro Black interior decoration	kit ruedas Castors kit
VVAM-6HE-9	223 €	300 €	240 €
VVAM-6HE-13	230 €	385 €	240 €

LUNNARIS

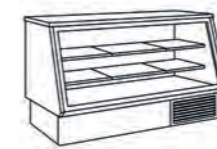

Fiabilidad y rendimiento en cada uso. Diseñado para conservar los alimentos en condiciones óptimas garantizando frescura y seguridad con eficiencia.

Reliability and performance with every use. Designed to efficiently preserve food in optimal conditions, ensuring freshness and safety.

OPCIONES DE PERSONALIZACIÓN • CUSTOMIZATION OPTIONS

OPCIÓN 1 • OPTION 1

Decoración total en acero inoxidable
(Sin incremento de precio)

Stainless steel total decoration
(No price increase)



OPCIÓN 2 • OPTION 2

Decoración exterior negro o blanco
(Incremento de precio)

Black or white external decoration
(Price increase)



CARACTERÍSTICAS CONSTRUCTIVAS • CONSTRUCTION FEATURES

- Exterior en acero inox AISI-304. Opcional negro / blanco
- Interior en acero inox AISI-304.
- Laterales ciegos en acero inox AISI-304.
- Encimera en acero inox AISI-304.
- Perfilería en aluminio anodizado.
- Puerta frontal vidrio doble.
- Aislamiento de poliuretano inyectado, densidad 40 Kg/m³, bajo GWP y cero efecto ODP.

- Exterior in AISI-304 stainless steel. Optional black / white
- Interior in AISI-304 stainless steel.
- Blind side panels in AISI-304 stainless steel.
- Countertop in AISI-304 stainless steel.
- Profiles in anodized aluminum.
- Front door with double glass.
- Injected polyurethane insulation, 40 kg/m³ density, low GWP and zero ODP impact.

COMPONENTES • COMPONENTS

- Puertas traseras con sistema de cierre automático y burlete magnético (permanece abierta al superar los 90° de apertura)
- Contrapuerta inox AISI-304.
- Patas reguladoras de altura.
- Iluminación interior LED.
- Estantes interiores en acero inox AISI-304 regulables en altura.
- Puerta frontal abatible de cristal doble sobre marco de aluminio anodizado.
- Evaporador estático con recubrimiento anticorrosión.
- Unidad condensadora ventilada.
- Chasis en acero acabado epoxy.
- Evaporación automática del agua de descarche
- Control digital de temperatura y descarches, eficiente en la gestión del consumo de energía.
- Incorpora enchufe auxiliar con capacidad máxima de carga de 500w.

- Rear doors with automatic closing system and magnetic gasket (remain open when opened beyond 90°).
- Inner door panel in AISI-304 stainless steel.
- Height-adjustable legs.
- Interior LED lighting.
- Height-adjustable interior shelves in AISI-304 stainless steel.
- Front tilting door with double glass, set in anodized aluminum frame.
- Static evaporator with anti-corrosion coating.
- Ventilated condensing unit.
- Chassis made of epoxy-coated steel.
- Automatic defrost water evaporation.
- Digital temperature and defrost control, energy-efficient management.
- Includes auxiliary outlet with a maximum load capacity of 500W.

DATOS TÉCNICOS • TECHNICAL FEATURES

- Clase climática 4, (30°C 55% H.R.)
- Temperatura de funcionamiento +0°C + 6°C
- Tensión de trabajo monofásica 220V 50Hz
- Tensión de trabajo monofásica 115V 60Hz o 220V 60Hz (consultar)

- Climate class 4 (30°C, 55% RH).
- Operating temperature: +0°C to +6°C
- Operating voltage: single-phase 220V 50Hz.
- Operating voltage: single-phase 115V 60Hz or 220V 60Hz (upon request)

TIPOS DE ILUMINACIÓN • TYPES OF LIGHTING



4000K

ESTÁNDAR / STANDARD



3000K

RED FRESH

OPCIONAL / OPTIONAL

LUNNARIS VCC-9

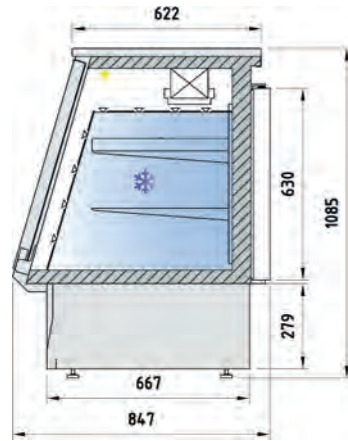



Detalle apertura frontal
Detail front opening



VCC-9-20 (Inox)



Detalle vista trasera
Rear view detail

Modelo Model	Largo Length (mm)	Área estantes refrigerados Refrigerated shelf area (m²)	Superficie total exposición (TDA) Total display area (TDA) (m²)	Volumen neto Net volume (Lts.)	Puertas Doors (Uds.)	Potencia frig. Frig. Power HC (W)	Consumo Nominal Nominal power HC (W)	
 VCC-9-13	1315	1.83	0.37	289	2	781	417	3.092 €
 VCC-9-15	1515	2.11	0.43	337	2	781	418	3.187 €
 VCC-9-20	2015	2.84	0.59	456	3	949	485	3.891 €

OPCIONALES · OPTIONS

Modelo Model	Cerradura puerta frontal Front door lock	Kit decoración exterior epoxi blanco o negro White or black epoxy exterior decoration kit	Kit puerta cristal trasera Kit rear door glass	kit ruedas Castors kit
VCC-9-13	64 €	810 €	462 €	240 €
VCC-9-15	64 €	835 €	462 €	240 €
VCC-9-20	64 €	856 €	693 €	360 €

MAPLE

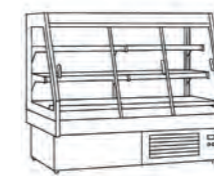

Como el árbol que simboliza nobleza y equilibrio, Maple es el refugio donde los alimentos se mantienen en su máximo esplendor. Un tributo a la naturaleza y su riqueza.

Like the tree that symbolizes nobility and balance, Maple is the refuge where food is kept at its peak. A tribute to nature and its richness.

OPCIONES DE PERSONALIZACIÓN • CUSTOMIZATION OPTIONS



OPCIÓN 1 • OPTION 1

Franja superior e intermedia en colores sólidos
(Sin incremento de precio)

Top and middle bands in solid colors
(No price increase)



OPCIÓN 2 • OPTION 2

Decoración frontal en colores sólidos
(Con incremento de precio)

Front decoration in solid colors
(Price increase)



OPCIÓN 3 • OPTION 3

Decoración total en colores carta RAL o NCS
(Con incremento de precio)

Total decoration in letter RAL o NCS
(Price increase)



OPCIÓN 4 • OPTION 4

Decoración total negro, gris o blanco
(Sin incremento de precio)

Total decoration black, gray or white
(No price increase)



OPCIÓN 5 • OPTION 5

Decoración alto brillo o carta Ral - NCS
(Con incremento de precio)

Decoración en madera - Consultar

High gloss decoration or RAL - NCS chart
(Price increase)

Wood decoration - Consult

CARACTERÍSTICAS CONSTRUCTIVAS • CONSTRUCTION FEATURES

- Mueble semivertical grupo incorporado con capacidad y visibilidad optimizada del producto.
- Gran posibilidad de personalización.
- Laterales vidrio panorámico, serigrafiado en negro RAL 9005 espesor 30mm
- Interior en acabado blanco RAL 9003. Opción negro RAL 9005 sin incremento de precio.
- Aislamiento de poliuretano inyectado, densidad 40kg/m³ bajo GWP y cero efecto ODP
- Paragolpes de tubo opcional en todos los modelos (no incluido de serie)

- Semi-vertical cabinet with built-in refrigeration unit, optimized for product capacity and visibility.
- Highly customizable.
- Panoramic glass side panels, black screen-printed RAL 9005, 30 mm thick.
- Interior in white finish RAL 9003. Black RAL 9005 option available at no extra cost.
- Injected polyurethane insulation, 40 kg/m³ density, low GWP and zero ODP impact.
- Optional tube bumper available for all models (not included as standard).

COMPONENTES • COMPONENTS

- SVS: Modelo con cortina de noche manual y frente cuba inferior de metacrilato
- SVG: Modelo con puertas correderas de cristal doble.
- Estantes regulables en altura, con portaprecios de 40 mm incluidos
- Evaporador ventilado con recubrimiento EPOXI anticorrosión.
- Patas reguladoras de altura
- Unidad condensadora Ventilada.
- Desescarche natural del evaporador
- Bandeja de evaporación automática.
- Ventiladores electromecánicos, opcional electrónicos (consultar)
- Control electrónico
- Iluminación LED 24v 4000k en visera
- Modelos preinstalación incorporan valvulería solenoide y expansión termostática en R-449A, opción R-134a (consultar otros refrigerantes)

- SVS: Model with manual night curtain and lower tank front in methacrylate.
- SVG: Model with sliding double-glass doors.
- Height-adjustable shelves with 40 mm price holders included.
- Ventilated evaporator with anti-corrosion EPOXY coating.
- Height-adjustable feet.
- Ventilated condensing unit.
- Natural defrost for the evaporator.
- Automatic evaporation tray.
- Electromechanical fans; electronic fans optional (please inquire).
- Electronic control.
- 24V 4000K LED lighting in the canopy.
- Pre-installation models include solenoid valve and thermostatic expansion valve for R-449A; R-134a option available (other refrigerants upon request).

DATOS TÉCNICOS • TECHNICAL FEATURES

- Temperatura de funcionamiento, según EN-ISO-23953:
- SVG M1: -1°+5°C
- SVS M2: -1°+7°C
- SVG Clase climática 4 (30°C, 55 H.R).
- SVS Clase climática 3 (25°C, 60 H.R).
- Tensión de trabajo monofásica 220V 50Hz
- Tensión de trabajo monofásica 115V 60Hz o 220v 60Hz (consultar)

- Operating temperature according to EN-ISO-23953:
- SVG M1: -1°C to +5°C
- SVS M2: -1°C to +7°C
- SVG: Climate class 4 (30°C, 55% RH).
- SVS: Climate class 3 (25°C, 60% RH).
- Operating voltage: single-phase 220V 50Hz.
- Operating voltage: single-phase 115V 60Hz or 220V 60Hz (upon request).

TIPOS DE ILUMINACIÓN • TYPES OF LIGHTING



4000K

ESTÁNDAR / STANDARD



3000K

OPCIONAL / OPTIONAL



RED FRESH

OPCIONAL / OPTIONAL

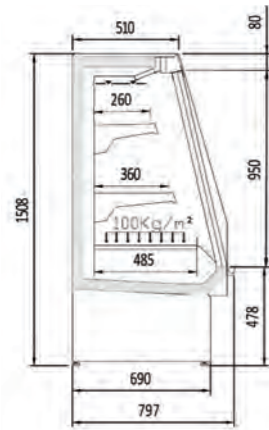

SVG1

MAPLE SVG1



SVG1 18 (Negro)

Total lacado interior, exterior negro
Total interior lacquer, black exterior

Modelo Model	Largo (con costados) Length (with sides)	Área estantes refrigerados Refrigerated shelf area	Superficie total exposición (TDA) Total display area (TDA)	Volumen neto Net volume	Estantes Shelves	Puertas Doors	Potencia frig. Frig. Power HC	Consumo Nominal Nominal power HC
	(mm)	(m²)	(m²)	(Lts.)	(Uds.)	(Uds.)	(W)	(W)



SVG1 09 M1 998 1.01 0.79 330 2 2 1192 1557 **4.828 €**



SVG1 12 M1 1310 1.35 1.09 421 2 2 1192 1639 **5.125 €**



SVG1 18 M1 1935 2.02 1.64 662 4 3 1528 1945 **6.367 €**

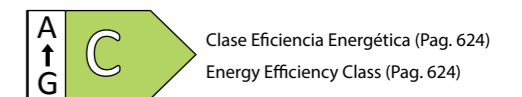

Clase Eficiencia Energética (Pag. 624)
Energy Efficiency Class (Pag. 624)

OPCIONALES · OPTIONS

Modelo Model	Decoración Frontal Front decor	Total decoración Total decor	Total decoración alto brillo Total decor	Tope estante metacrilato Methacrylate shelf stopper	Paragolpes tubo inox. Stainless steel bumper	Iluminación LED X nivel de estantes LED Ligthing X shelves level	Pre Instalación Remote Unit
SVG 09	271 €	471 €	627 €	36 €	59 €	59 €	-223 €
SVG 12	286 €	479 €	646 €	39 €	75 €	77 €	-275 €
SVG 18	317 €	492 €	673 €	57 €	108 €	114 €	-327 €

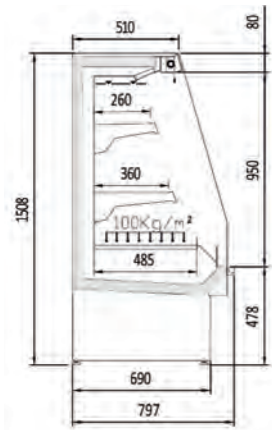

SVS1

MAPLE SVS1

docriluc





SEMIMURALES

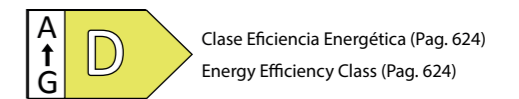



SVS1 12 (Perla)



Clase Eficiencia Energética (Pag. 624)
Energy Efficiency Class (Pag. 624)

Modelo Model	Largo (con costados) Length (with sides)	Área estantes refrigerados Refrigerated shelf area	Superficie total exposición (TDA) Total display area (TDA)	Volumen neto Net volume	Estantes Shelves	Puertas Doors	Potencia frig. Frig. Power HC	Consumo No- minal Nominal power HC	
	(mm)	(m²)	(m²)	(Lts.)	(Uds.)	(Uds.)	(W)	(W)	
 SVS1 06 M2	685	0,67	0,57	212	2	-	1192	1382	2.967 €
 SVS1 09 M2	998	1,01	0,80	330	2	-	1528	1713	3.439 €
 SVS1 12 M2	1310	1,35	1,10	421	2	-	1931	1885	3.640 €
 SVS1 15 M2	1623	1,69	1,35	564	4	-	2384	2368	4.640 €
 SVS1 18 M2	1935	2,02	1,66	662	4	-	3056	3026	4.663 €

OPCIONALES · OPTIONS

Modelo Model	Decoración Frontal Front decor	Total decoración Total decor	Total decoración alto brillo Total decor	Tope estante metacrilato Methacrylate shelf stopper	Paragolpes tubo inox. Stainless steel bumper	Iluminación LED X nivel de estantes LED Ligthing X shelves level	Pre Instalación Remote Unit
SVS 06							
SVS 06	260 €	463 €	613 €	31 €	45 €	40 €	-166 €
SVS 09	271 €	471 €	627 €	36 €	59 €	59 €	-223 €
SVS 12	286 €	479 €	646 €	39 €	75 €	77 €	-275 €
SVS 15	271 €	471 €	627 €	36 €	59 €	82 €	-286 €
SVS 18	317 €	492 €	673 €	57 €	108 €	114 €	-327 €

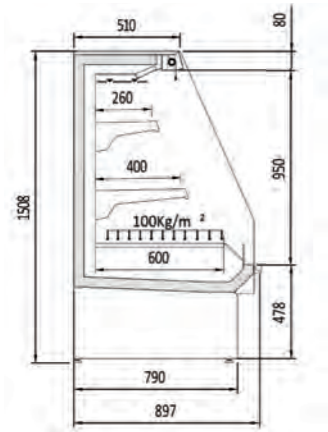





SVS3

MAPLE SVS3





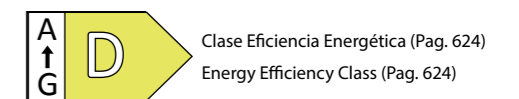

SVS3 12 (Gris Pizarra)

Modelo Model	Largo (con costados) Length (with sides)	Área estantes refrigerados Refrigerated shelf area	Superficie total exposición (TDA) Total display area (TDA)	Volumen neto Net volume	Estantes Shelves	Puertas Doors	Potencia frig. Frig. Power HC	Consumo No- minal Nominal power HC	
	(mm)	(m²)	(m²)	(Lts.)	(Uds.)	(Uds.)	(W)	(W)	
 SVS3 06 M2	685	0,77	0,61	254	2	-	1192	1382	3.025 €
 SVS3 09 M2	998	1,15	0,90	396	2	-	1528	1713	3.456 €
 SVS3 12 M2	1310	1,54	1,21	505	2	-	1931	1885	3.795 €
 SVS3 15 M2	1623	1,92	1,52	677	4	-	2384	2368	4.532 €
 SVS3 18 M2	1935	2,32	1,81	794	4	-	3056	3026	4.683 €



Clase Eficiencia Energética (Pag. 624)
Energy Efficiency Class (Pag. 624)

OPCIONALES · OPTIONS

Modelo Model	Decoración Frontal Front decor	Total decoración Total decor	Total decoración alto brillo Total decor	Tope estante metacrilato Methacrylate shelf stopper	Paragolpes tubo inox. Stainless steel bumper	Iluminación LED X nivel de estantes LED Ligthing X shelves level	Pre Instalación Remote Unit
SVS 06							
SVS 06	260 €	463 €	613 €	31 €	45 €	40 €	-166 €
SVS 09	271 €	471 €	627 €	36 €	59 €	59 €	-223 €
SVS 12	286 €	479 €	646 €	39 €	75 €	77 €	-275 €
SVS 15	271 €	471 €	627 €	36 €	59 €	82 €	-286 €
SVS 18	317 €	492 €	673 €	57 €	108 €	114 €	-327 €

AZALEA

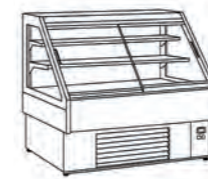

Sofisticación y frescura en un solo lugar. Azalea envuelve los productos con un toque de elegancia, manteniendo la vitalidad y el color como si estuvieran recién cosechados.

Sophistication and freshness in one. Azalea envelops produce with a touch of elegance, maintaining its vitality and color as if it were freshly harvested.

OPCIONES DE PERSONALIZACIÓN • CUSTOMIZATION OPTIONS



OPCIÓN 1 • OPTION 1

Franja superior e intermedia en colores sólidos
(Sin incremento de precio)

Top and middle bands in solid colors
(No price increase)



OPCIÓN 2 • OPTION 2

Decoración frontal en colores sólidos
(Con incremento de precio)

Front decoration in solid colors
(Price increase)



OPCIÓN 3 • OPTION 3

Decoración total en colores carta RAL o NCS
(Con incremento de precio)

Total decoration in letter RAL o NCS
(Price increase)



OPCIÓN 4 • OPTION 4

Decoración alto brillo o carta Ral - NCS
(Con incremento de precio)

High gloss decoration or RAL - NCS chart
(Price increase)



OPCIÓN 5 • OPTION 5

Decoración total negro, gris o blanco
(Sin incremento de precio)

Decoración en madera - Consultar

Total decoration black, gray or white
(No price increase)

Wood decoration - Consult

CARACTERÍSTICAS CONSTRUCTIVAS • CONSTRUCTION FEATURES

- Mueble semivertical grupo incorporado de altura reducida para adaptarse a las características interiores del recinto.
- Laterales vidrio panorámico, serigrafiado en negro RAL 9005 espesor 30mm
- Estándar interior en acero inoxidable.
- Gran posibilidad de personalización.
- Aislamiento de poliuretano inyectado, densidad 40kg/m³ bajo GWP y cero efecto ODP.
- El paragolpes de tubo es opcional en todos los modelos (no incluido de serie)

- Semi-vertical cabinet with built-in refrigeration unit and reduced height, designed to fit indoor architectural constraints.
- Panoramic glass side panels, black screen-printed RAL 9005, 30 mm thick.
- Standard interior in stainless steel.
- Highly customizable.
- Injected polyurethane insulation, 40 kg/m³ density, low GWP and zero ODP impact.
- Optional tube bumper available for all models (not included as standard).

COMPONENTES • COMPONENTS

- PPS: Modelo con Cortina de noche manual y frente cuba inferior de metacrilato.
- PPG: Modelo con puertas correderas de cristal doble.
- Evaporador ventilado pintado en EPOXI con recubrimiento anti-corrosión.
- Estantes en cristal securizado, regulables en altura, con portaprecios de 40 mm incluidos.
- Desescarche natural del evaporador.
- Unidad condensadora Ventilada.
- Bandeja de evaporación automática.
- Ventiladores electromecánicos.
- Patas reguladoras de altura.
- Control electrónico.
- Iluminación LED 24v 4000k en visera.
- Modelos preinstalación incorporan valvulería solenoide y expansión termostática en R-449A, opción R-134a (consultar otros refrigerantes).

- PPS: Model with manual night curtain and lower tank front in methacrylate.
- PPG: Model with sliding double-glass doors.
- Ventilated evaporator with anti-corrosion EPOXY coating.
- Height-adjustable tempered glass shelves with 40 mm price holders included.
- Natural defrost for the evaporator.
- Ventilated condensing unit.
- Automatic evaporation tray.
- Electromechanical fans.
- Height-adjustable legs.
- Electronic control.
- 24V 4000K LED lighting in the canopy.
- Pre-installation models include solenoid valve and thermostatic expansion valve for R-449A; R-134a option available (other refrigerants upon request).

DATOS TÉCNICOS • TECHNICAL FEATURES

- Temperatura de funcionamiento, según EN-ISO-23953:
- PPG - M1: -1°+5°C, apropiado para carnes.
- PPS - M2: -1°+7°C, apropiado para lácteos, delis y embutidos.
- Clase climática 3 (25°C, 60 H.R).
- Tensión de trabajo monofásica 220V 50Hz
- Tensión de trabajo monofásica 115V 60Hz o 220v 60Hz (consultar)

- Operating temperature according to EN-ISO-23953:
- PPG - M1: -1°C to +5°C, suitable for meats.
- PPS - M2: -1°C to +7°C, suitable for dairy, deli, and cold cuts.
- Climate class 3 (25°C, 60% RH).
- Operating voltage: single-phase 220V 50Hz.
- Operating voltage: single-phase 115V 60Hz or 220V 60Hz (upon request).

TIPOS DE ILUMINACIÓN • TYPES OF LIGHTING



4000K

ESTÁNDAR / STANDARD

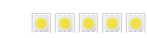

3000K



RED FRESH

OPCIONAL / OPTIONAL

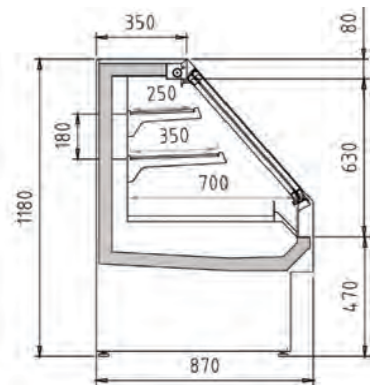

PPG



AZALEA PPG

docriluc

SEMIMURALES



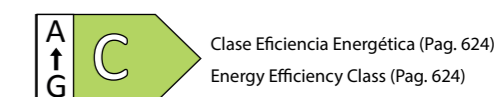

PPG11354 12 (Gris Plomo)

Modelo Model	Largo (con costados) Length (with sides) (mm)	Área estantes refrigerados Refrigerated shelf area (m²)	Superficie total exposición (TDA) Total display area (TDA) (m²)	Volumen neto Net volume (Lts.)	Estantes Shelves (Uds.)	Potencia frig. Frig. Power HC (W)	Consumo Nominal Nominal power HC (W)	
 PPG11354 12	1310	1.55	1.07	210	2	1214	1674	5.734 €
 PPG11354 18	1935	2.3	1.66	311	4	2056	2041	7.335 €
 PPG11354 25	2560	3.05	2.21	414	4	2492	3091	10.202 €



Clase Eficiencia Energética (Pag. 624)
Energy Efficiency Class (Pag. 624)

OPCIONALES · OPTIONS

Modelo Model	Decoración Frontal Front decor	Total decoración Total decor	Total decoración alto brillo Total decor	Tope estante metacrilato Methacrylate shelf stopper	Paragolpes tubo inox. Stainless steel bumper	Iluminación LED X nivel de estantes LED Ligthing X shelves level	Pre Instalación Remote Unit
PPG11354 12	 286 €	 479 €	 646 €	39 €	75 €	77 €	-275 €
PPG11354 18	317 €	492 €	673 €	57 €	108 €	114 €	-327 €
PPG11354 25	328 €	499 €	686 €	67 €	151 €	154 €	-530 €

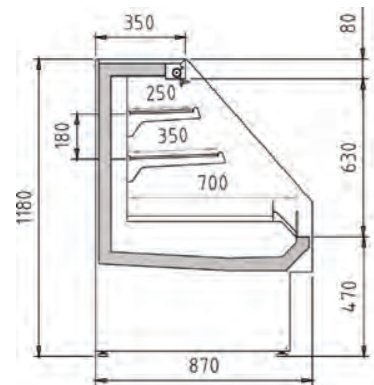



PPS

AZALEA PPS



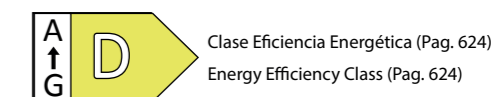

PPS11354 18 (Negro)

Modelo Model	Largo (con costados) Length (with sides) (mm)	Área estantes refrigerados Refrigerated shelf area (m²)	Superficie total exposición (TDA) Total display area (TDA) (m²)	Volumen neto Net volume (Lts.)	Estantes Shelves (Uds.)	Potencia frig. Frig. Power HC (W)	Consumo Nominal Nominal power HC (W)	
 PPS11354 12	1310	1.55	1.07	210	2	1214	1674	4.679 €
 PPS11354 18	1935	2.3	1.66	311	4	2056	2041	5.745 €
 PPS11354 25	2560	3.05	2.21	414	4	2492	3091	8.091 €



Clase Eficiencia Energética (Pag. 624)
Energy Efficiency Class (Pag. 624)

OPCIONALES · OPTIONS

Modelo Model	Decoración Frontal Front decor	Total decoración Total decor	Total decoración alto brillo Total decor	Tope estante metacrilato Methacrylate shelf stopper	Paragolpes tubo inox. Stainless steel bumper	Iluminación LED X nivel de estantes LED Ligthing X shelves level	Pre Instalación Remote Unit
PPS11354 12	 286 €	 479 €	 646 €	39 €	75 €	77 €	-275 €
PPS11354 18	317 €	492 €	673 €	57 €	108 €	114 €	-327 €
PPS11354 25	328 €	499 €	686 €	67 €	151 €	154 €	-530 €

VITRINAS MURALES

MULTIDECK DISPLAYS

docriluc



INGENIOUS - 237

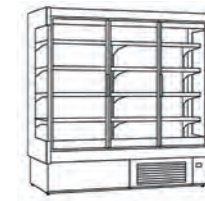

CEDAR - 251

INGENIOUS



Más que una vitrina, Ingenious es la combinación perfecta entre innovación y eficiencia. Diseñado para mantener la frescura y calidad de los alimentos con la máxima precisión.

More than just a display case, Ingenious is the perfect combination of innovation and efficiency. Designed to maintain food freshness and quality with the utmost precision.



OPCIONES DE PERSONALIZACIÓN • CUSTOMIZATION OPTIONS



OPCIÓN 1 • OPTION 1

Decoración total en color negro
(Sin incremento de precio)

Total decoration in black color
(No price increase)



OPCIÓN 2 • OPTION 2

Decoración total en colores carta RAL o NCS
(Con incremento de precio)

Total decoration in letter RAL o NCS
(Price increase)



Opción costado ciego
Blind side option
Disponibles modelos refrigeración y congelados
Available refrigerated and frozen models



Opción costado ventana
Window side option
Solo modelos refrigeración
Refrigeration models only

CARACTERÍSTICAS CONSTRUCTIVAS • CONSTRUCTION FEATURES

- Mueble vertical grupo incorporado con capacidad y visibilidad optimizada del producto.
- Vidrio doble. Refrigeración.
- Vidrio triple. Congelación.
- Disponible en dos alturas:
 - a. EFI: 2160mm.
 - b. EFIL: 2000mm.
- Diferentes tipos de laterales:
 - a) Laterales ciegos.
 - b) Lateral ventana solo disponible en modelo refrigeración.
- Exterior negro RAL 9005.
- Interior en acabado blanco RAL 9003. Opción negro RAL 9005 sin incremento de precio.
- Aislamiento de poliuretano inyectado, densidad 40kg/m³ bajo GWP y cero efecto ODP.

- Vertical cabinet with built-in refrigeration unit, optimized for product capacity and visibility.
- Double glass for refrigeration models.
- Triple glass for freezing models.
- Available in two heights:
 - a. EFI: 2160 mm.
 - b. EFIL: 2000 mm.
- Different side panel types:
 - a) Solid sides.
 - b) Window side panel available only on refrigeration models.
- Exterior in black RAL 9005.
- Interior finished in white RAL 9003. Black RAL 9005 option at no extra cost.
- Injected polyurethane insulation, 40 kg/m³ density, low GWP and zero ODP impact.

COMPONENTES • COMPONENTS

- Puertas abatibles sin marco y frontal completo de cristal con serigrafía mínima con sistema de cierre automático y burlete magnético (permanece abierta al superar los 90° de apertura).
- Estantes regulables en altura y ángulo, con portaprecios de 40 mm incluidos.
- Configuraciones disponibles:
 - a. EFILP: Vitrina refrigerada de pastelería, con estantes de vidrio securizado regulables en altura.
 - b. EFILQ: Vitrina refrigerada para quesos. Interior en acero inox AISI-316 con estantes de acero perforados, regulables en altura. (opción estantes de vidrio securizado)
 - c. EFI / EFIL: Opción de estantes de varilla en modelo congelación.
- Evaporador ventilado pintado con recubrimiento anticorrosión.
- Unidad condensadora Ventilada.
- Estantes regulables en altura y ángulo, con portaprecios de 40 mm incluidos
- Desescarche natural del evaporador
- Bandeja de evaporación automática
- Control electrónico.
- Patas reguladoras de altura.
- Iluminación LED 24v 4000k en estantes.

- Hinged doors without frame and full glass front with minimal screen printing, automatic closing system and magnetic gasket (remains open if opened beyond 90°).
- Shelves adjustable in height and angle, with 40 mm price holders included.
- Available configurations:
 - a. EFILP: Refrigerated pastry display case, with height-adjustable tempered glass shelves.
 - b. EFILQ: Refrigerated cheese display case. Interior in AISI-316 stainless steel with height-adjustable perforated steel shelves (optional tempered glass shelves).
 - c. EFI / EFIL: Wire shelving option for freezing models.
- Ventilated evaporator with anti-corrosion coating.
- Ventilated condensing unit.
- Natural evaporator defrost.
- Automatic evaporation tray.
- Electronic control.
- Height-adjustable feet.
- 24V 4000K LED lighting on shelves.

DATOS TÉCNICOS • TECHNICAL FEATURES

- Temperatura de producto, según EN-ISO-23953:
 - d. EFI-R / EFIL-R M1: -1°+5°C, apropiado para carnes, lácteos, delis y embutidos
 - e. EFI-C / EFIL-C L1: -15°-18°C, apropiado para producto congelado
- Clase climática 3 (25°C, 60 H.R)
- Tensión de trabajo monofásica 220V 50Hz
- Tensión de trabajo monofásica 115V 60Hz o 220v 60Hz (consultar)
- Gas refrigerante R-290

- Operating temperature according to EN-ISO-23953:
 - d. EFI-R / EFIL-R M1: -1°C to +5°C, suitable for meat, dairy, deli, and cold cuts.
 - e. EFI-C / EFIL-C L1: -15°C to -18°C, suitable for frozen products.
- Climate class 3 (25°C, 60% RH).
- Operating voltage: single-phase 220V 50Hz.
- Operating voltage: single-phase 115V 60Hz or 220V 60Hz (upon request).
- R-290 refrigerant gas

TIPOS DE ILUMINACIÓN • TYPES OF LIGHTING



4000K

ESTÁNDAR / STANDARD



3000K





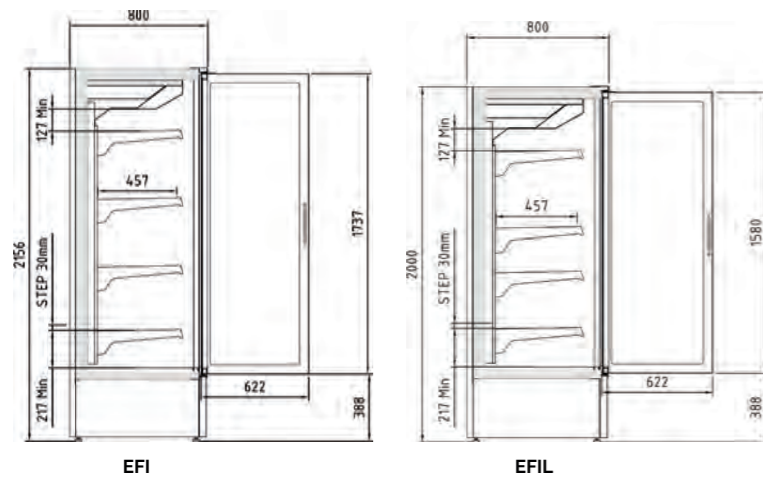

RED FRESH

OPCIONAL / OPTIONAL



MURALES

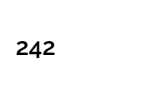

Modelo Model	Largo Length (mm)	Alto Height (mm)	Fondo Depth (mm)	Área estantes refrigerados Refrigerated shelf area	Superficie total exposición Total display area (TDA)	Volumen neto Net volume (L)	Volumen bruto Gross volume (L)	Estantes Shelves (Uds.)	Puertas Doors (Uds.)	Potencia frig. Frig power (W)	Consumo nominal Nominal power (W)	Modelo LC LC Model	Modelo LV LV Model
 EFI 1R	642	2160	800	1.20	0.84	430	461	4	1	555	1132	2.801 €	2.831 €
 EFIL 1R	642	2000	800	1.20	0.78	398	428	4	1	555	1132	2.643 €	2.672 €
 EFI 2R	1282	2160	800	2.72	1.68	859	1010	4	2	1192	1508	4.152 €	4.190 €
 EFIL 2R	1282	2000	800	2.72	1.55	797	937	4	2	1192	1508	4.077 €	4.115 €
 EFI 3R	1925	2160	800	4.29	2.52	1253	1570	8	3	1528	1945	5.819 €	5.868 €
 EFIL 3R	1925	2000	800	4.29	2.33	1162	1456	8	3	1528	1945	5.337 €	5.384 €
 EFI 4R	2567	2160	800	5.82	3.30	1667	2128	8	4	2384	3016	7.473 €	7.564 €
 EFIL 4R	2567	2000	800	5.82	3.06	1546	1974	8	4	2384	3016	7.326 €	7.415 €

EFI-4R (Negro)



Tu elección rápida, en stock, siempre listo
 Disponible en decoración exterior color negro
 Your quick choice, always in stock, always ready
 Available in black exterior finish



Clase Eficiencia Energética (Pag. 624)
 Energy Efficiency Class (Pag. 624)

OPCIONALES · OPTIONS

Modelo Model	Estante adicional x nivel Additional shelf x level	Ventiladores electrónicos Electronic fans	Kit exterior lacado (Góndola + costados) Lacquered exterior kit (Gondola + sides)
EFI / EFIL-1R	123 €	72 €	463 €
EFI / EFIL-2R	164 €	89 €	479 €
EFI / EFIL-3R	263 €	135 €	493 €
EFI / EFIL-4R	328 €	179 €	499 €

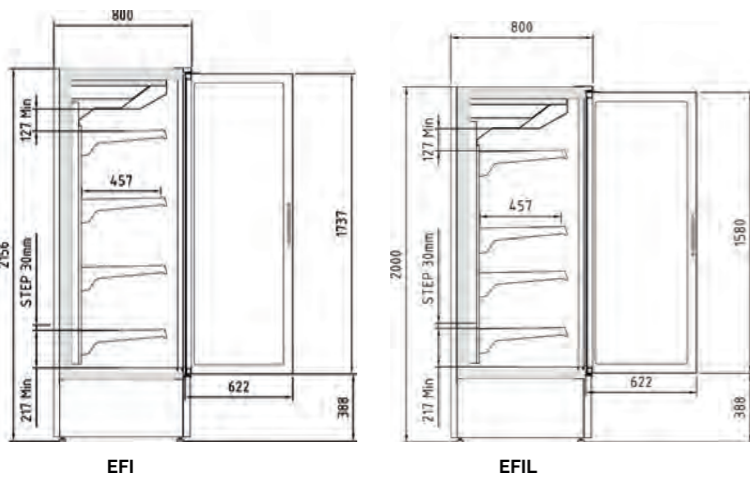

Detalle apertura puertas
Open door detail

INGENIOUS EFI-C

docriluc

MURALES



EFIL-3C (Negro)

Modelo	Largo	Alto	Fondo	Área estantes refrigerados	Superficie total exposición	Volumen neto	Volumen bruto	Estantes	Puertas	Potencia frig.	Consumo nominal	
Model	Length	Height	Depth	Refrigerated shelf area	Total display area	Net volume	Gross volume	Shelves	Doors	Frig power	Nominal power	
	(mm)	(mm)	(mm)		(TDA)	(L)	(L)	(Uds.)	(Uds.)	(W)	(W)	
EFI 1C	642	2160	800	1,20	0,84	430	461	4	1	495	474	3.733 €
EFIL 1C	642	2000	800	1,20	0,78	398	428	4	1	495	474	3.638 €
EFI 2C	1282	2160	800	2,72	1,68	859	1010	4	2	924	1733	5.687 €
EFIL 2C	1282	2000	800	2,72	1,55	797	937	4	2	924	1733	5.542 €
EFI 3C	1925	2160	800	4,29	2,52	1253	1570	8	3	1242	2162	7.213 €
EFIL 3C	1925	2000	800	4,29	2,33	1162	1456	8	3	1242	2162	7.029 €
EFI 4C	2567	2160	800	5,82	3,30	1667	2128	8	4	1848	3466	8.806 €
EFIL 4C	2567	2000	800	5,82	3,06	1546	1974	8	4	1848	3466	8.619 €



Tu elección rápida, en stock, siempre listo
 Disponible en decoración exterior color negro
 Your quick choice, always in stock, always ready
 Available in black exterior finish



Clase Eficiencia Energética (Pag. 624)
 Energy Efficiency Class (Pag. 624)

OPCIONALES · OPTIONS

Modelo	Estante adicional x nivel	Ventiladores electrónicos	Kit estante varilla	Kit exterior lacado (Góndola + costados)
Model	Additional shelf x level	Electronic fans	Rod shelf kit	Lacquered exterior kit (Gondola + sides)
EFI / EFIL-1C	123 €	72 €	96 €	463 €
EFI / EFIL-2C	164 €	89 €	96 €	479 €
EFI / EFIL-3C	263 €	135 €	96 €	493 €
EFI / EFIL-4C	328 €	179 €	96 €	499 €

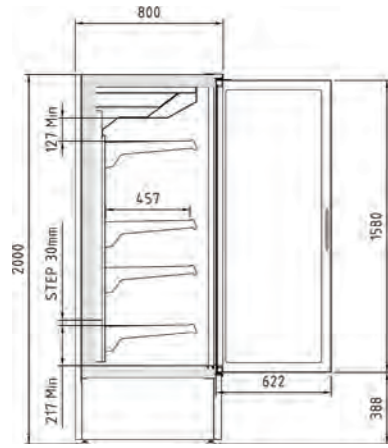

EFI PUERTA ABIERTA



Detalle estante de cristal
Glass shelf detail



EFILP-2R
Costado ciego
Blind side



EFILP-2R (RAL 190 80 25)



Clase Eficiencia Energética (Pag. 624)
Energy Efficiency Class (Pag. 624)

Modelo	Largo	Alto	Fondo	Área estantes refrigerados	Superficie total exposición	Volumen neto	Volumen bruto	Estantes	Puertas	Potencia frig.	Consumo nominal	Modelo LC	Modelo LV
Model	Length	Height	Depth	Refrigerated shelf area	Total display area	Net volume	Gross volume	Shelves	Doors	Frig power	Nominal power	LC Model	LV Model
	(mm)	(mm)	(mm)		(TDA)	(L)	(L)	(Uds.)	(Uds.)	(W)	(W)		

	EFILP-1R	642	2000	800	1.20	0.78	398	428	4	1	555	1132	3.303 €	3.337 €
---	----------	-----	------	-----	------	------	-----	-----	---	---	-----	------	----------------	----------------

	EFILP-2R	1282	2000	800	2.72	1.55	797	937	4	2	1192	1508	4.762 €	4.806 €
---	----------	------	------	-----	------	------	-----	-----	---	---	------	------	----------------	----------------

	EFILP-3R	1925	2000	800	4.29	2.33	1162	1456	8	3	1528	1945	6.001 €	6.083 €
---	----------	------	------	-----	------	------	------	------	---	---	------	------	----------------	----------------

OPCIONALES · OPTIONS

Modelo	Estante adicional x nivel	Kit interior acero inox brillo	Ventiladores electrónicos	Kit exterior lacado (Góndola + costados)
Model	Additional shelf x level	Interior kit polished stainless steel	Electronic fans	Lacquered exterior kit (Gondola + sides)
EFILP-1R	123 €	319 €	72 €	463 €
EFILP-2R	164 €	551 €	89 €	479 €
EFILP-3R	263 €	995 €	135 €	493 €

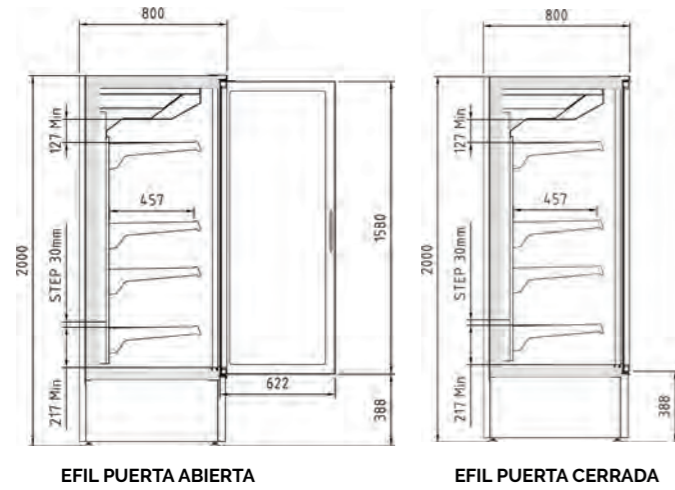

Detalle estante de cristal (Sin incremento de precio)
Glass shelf detail (No price increase)



EFILQ-2R (Negro)

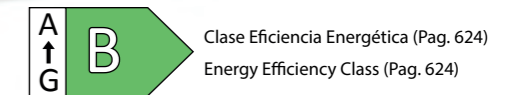

Clase Eficiencia Energética (Pag. 624)
Energy Efficiency Class (Pag. 624)

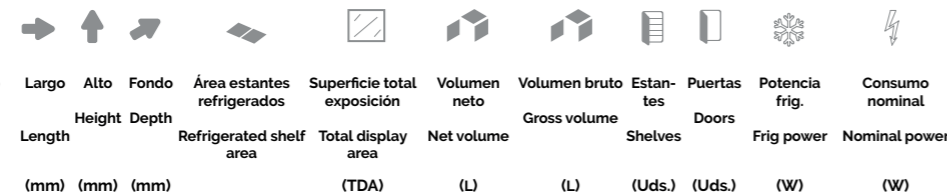

Modelo	Largo	Alto	Fondo	Área estantes refrigerados	Superficie total exposición	Volumen neto	Volumen bruto	Estantes	Puertas	Potencia frig.	Consumo nominal	Modelo LC	Modelo LV
Model	Length	Height	Depth	Refrigerated shelf area	Total display area	Net volume	Gross volume	Shelves	Doors	Frig power	Nominal power	LC Model	LV Model
	(mm)	(mm)	(mm)		(TDA)	(L)	(L)	(Uds.)	(Uds.)	(W)	(W)		
EFILQ-1R	642	2000	800	1.20	0.78	398	428	4	1	555	1132	4.546 €	4.501 €
EFILQ-2R	1282	2000	800	2.72	1.55	797	937	4	2	1192	1508	6.318 €	6.377 €
EFILQ-3R	1925	2000	800	4.29	2.33	1162	1456	8	3	1528	1945	8.088 €	8.198 €

OPCIONALES · OPTIONS

Modelo	Estante adicional x nivel	Ventiladores electrónicos	Kit exterior lacado (Góndola + costados)
Model	Additional shelf x level	Electronic fans	Lacquered exterior kit (Gondola + sides)
EFILQ-1R	123 €	72 €	463 €
EFILQ-2R	164 €	89 €	479 €
EFILQ-3R	263 €	135 €	493 €

CEDAR

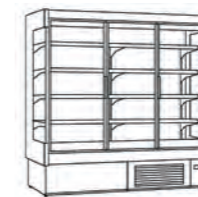

Inspirado en la fortaleza y calidez del cedro, Cedar es el guardián de la frescura y el sabor. Su elegancia natural resalta cada ingrediente, manteniéndolo en su punto óptimo para deleitar los sentidos.

Inspired by the strength and warmth of Cedar, Cedar is the guardian of freshness and flavor. Its natural elegance highlights each ingredient, keeping it at its peak to delight the senses.



OPCIONES DE PERSONALIZACIÓN • CUSTOMIZATION OPTIONS



OPCIÓN 1 • OPTION 1

Decoración frontal en colores sólidos
(Sin incremento de precio)

Front decoration in solid colors
(No price increase)



OPCIÓN 2 • OPTION 2

Decoración frontal completa en colores sólidos, NCS o RAL
(Incremento de precio)

Full front decoration in solid colors, NCS or RAL
(Price increase)



OPCIÓN 3 • OPTION 3

Decoración total en colores sólidos, RAL o NCS
(Incremento de precio)

Total decoration in solid colors, RAL or NCS
(Price increase)



OPCIÓN 4 • OPTION 4

Decoración total negro, gris o blanco
(Sin incremento de precio)

Total decoration black, gray or white
(No price increase)



OPCIÓN 5 • OPTION 5

Decoración alto brillo
(Consultar)

Decoración en madera - Consultar

High gloss decoration
(Consult)

Wood decoration - Consult

CARACTERÍSTICAS CONSTRUCTIVAS • CONSTRUCTION FEATURES

- Mueble vertical grupo incorporado con capacidad y visibilidad optimizada del producto.
 - Diferentes tipos de laterales:
 - a) ABS con vidrio doble.
 - b) LC. Lateral ciego espejo interior.
 - c) LV. Lateral ventana con vidrio doble.
 - d) LE. Lateral panorámico vidrio doble, serigrafiado en negro.
 - Gran posibilidad de personalización.
 - Interior en acabado blanco RAL 9003. Opción negro RAL 9005 sin incremento de precio.
 - Modelo INOX: Interior y exterior en acero INOX AISI-304
 - Aislamiento de poliuretano inyectado, densidad 40kg/m³ bajo GWP y cero efecto ODP.
 - El paragolpes de tubo es opcional en todos los modelos. (no incluido de serie)
- DG / DS
- Vertical cabinet with built-in refrigeration unit, optimized for product capacity and visibility.
 - Various side panel types:
 - a) ABS with double-glass.
 - b) LC: Solid side panel with internal mirror.
 - c) LV: Windowed side panel with double-glass.
 - d) LE: Panoramic double-glass side panel, black screen-printed.
 - Highly customizable.
 - Interior in white finish RAL 9003. Black RAL 9005 option available at no extra cost.
 - INOX model: Interior and exterior in AISI-304 stainless steel.
 - Injected polyurethane insulation, 40 kg/m³ density, low GWP and zero ODP impact.
 - Optional tube bumper available for all models (not included as standard)
- HDG
- Bajo consumo energético.
 - Lateral exterior panorámico incluido en el precio.
 - Exterior lacado o inox incluido en PVP.
 - Compresor inverter de velocidad variable.
 - Ventiladores electrónicos.
 - Válvula de expansión electrónica. (solo modelos 09 y 12).
 - Termostato EMS.
 - Puertas de cristal doble con iluminación vertical.
 - Nivel sonoro modelo HDG 09: 36db.
 - Nivel sonoro modelo HDG 12: 45db.
 - Nivel sonoro modelo HDG 18: 48db.

COMPONENTES • COMPONENTS

- DS: Modelo con cortina de noche manual y frente cuba inferior de metacrilato.
 - DG: Modelo con puertas abatibles de vidrio con serigrafía mínima e iluminación vertical. apertura permitida, hasta 93° y bloqueo de cierre manual. Autocierre con barra de torsión.
 - H1: Modelo de verduras con tope de metacrilato frontal en estantes y espejo superior.
 - Estantes regulables en altura y ángulo, con portaprecios de 40 mm incluidos.
 - Patas reguladoras de altura.
 - Evaporador ventilado con recubrimiento EPOXI anticorrosión.
 - Unidad condensadora Ventilada.
 - Desescarche natural del evaporador.
 - Bandeja de evaporación automática.
 - Ventiladores electromecánicos, opcional electrónicos (consultar)
 - Control electrónico.
 - Iluminación LED 24v 4000k en visera (iluminación vertical solo en modelos DG)
 - Modelos preinstalación incorporan valvulería solenoide y expansión termostática en R-449A, opción R-134a (consultar otros refrigerantes).
- DS: Model with manual night curtain and lower tank front in methacrylate.
- DG: Model with hinged glass doors featuring minimal screen printing and vertical lighting; opens up to 93° and includes manual locking system. Self-closing with torsion bar.
- H1: Produce model with front methacrylate stop on shelves and upper mirror.
- Height- and angle-adjustable shelves with 40 mm price holders included.
- Height-adjustable feet.
- Ventilated evaporator with anti-corrosion EPOXY coating.
- Ventilated condensing unit.
- Natural defrost for the evaporator.
- Automatic evaporation tray.
- Electromechanical fans; electronic fans optional (upon request).
- Electronic control.
- 24V 4000K LED lighting in the canopy (vertical lighting only in DG models).
- Pre-installation models include solenoid valve and thermostatic expansion valve for R-449A; R-134a option available (other refrigerants upon request)

DATOS TÉCNICOS • TECHNICAL FEATURES

- Temperatura de producto, según EN-ISO-23953:
 - HDG / DG: M1: -1°+5°C, apropiado para carnes.
 - DS / DG: M2: -1°+7°C, apropiado para lácteos, delis y embutidos.
 - DS / DG: H1: +1°+10°C, apropiado para frutas y verduras.
 - Clase climática 3 (25°C, 60 H.R.)
 - Tensión de trabajo monofásica 220V 50Hz
 - Tensión de trabajo monofásica 115V 60Hz o 220v 60Hz (consultar)
 - Gas refrigerante R-290
- Product temperature according to EN-ISO-23953:
- HDG /DG: M1: -1°C to +5°C, suitable for meat.
- DS / DG: M2: -1°C to +7°C, suitable for dairy, deli, and cold cuts.
- DS / DG: H1: +1°C to +10°C, suitable for fruits and vegetables.
- Climate class 3 (25°C, 60% RH).
- Operating voltage: single-phase 220V 50Hz.
- Operating voltage: single-phase 115V 60Hz or 220V 60Hz (upon request).
- R-290 refrigerant gas

TIPOS DE ILUMINACIÓN • TYPES OF LIGHTING



4000K

ESTÁNDAR / STANDARD

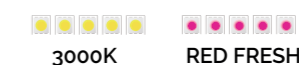

3000K

RED FRESH

OPCIONAL / OPTIONAL

MODELOS DE COSTADOS / SIDE MODELS



Lateral modelo panorámico LE
Model panoramic side LE



Lateral modelo plástico (De serie)
Model plastic side (As standard)



Lateral modelo cerrado LC
Model cosed side LC



Lateral modelo ventana LV
Model windows side LV

OPCIONALES CEDAR / CEDAR OPTIONS



Pincho - Spike

46 €



Gancho - Hook

41 €



Separador genero
Product separator

85 €



Barras carniceras - Butcher bars
Consultar - Consult



Frente metacrilato - Methacrylate front

Modelo Model	Tope estante metacrilato Methacrylate shelf stopper
DG3 / DS3 06	31 €
DG3 / DS3 09	36 €
DG3 / DS3 12	39 €
DG3 / DS3 15	41 €
DG3 / DS3 18	57 €
DG3 / DS3 25	67 €
DG3 31	83 €

Separador ambiente
Ambient separator

279 €

Detalle opcionales - optional detail

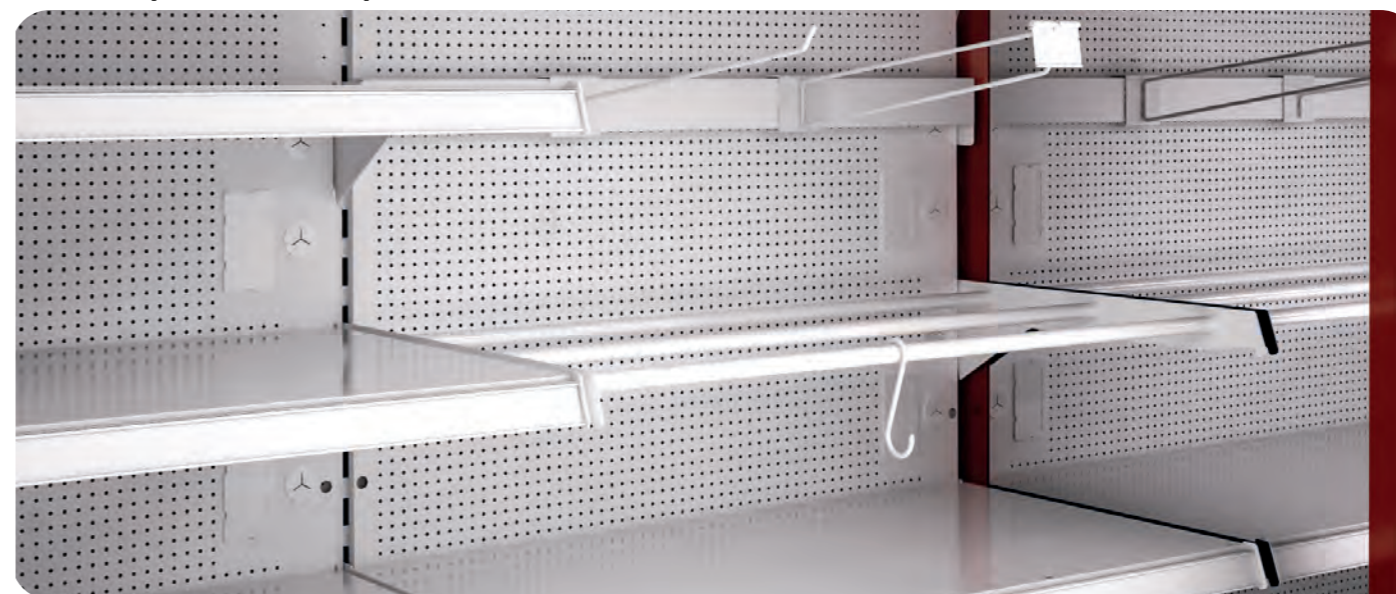

CEDAR HDG M1

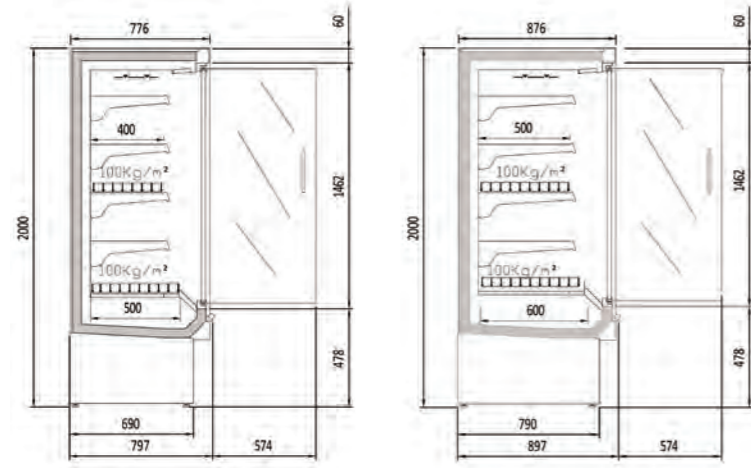

HDG1 M1

HDG3 M1

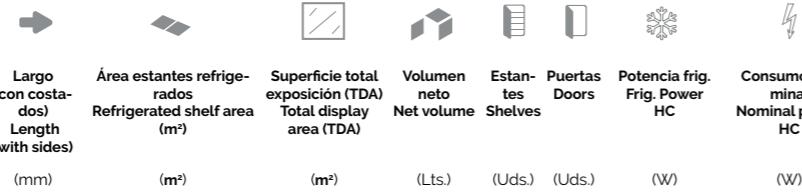

Modelo Model	Largo (con costados) Length (with sides) (mm)	Área estantes refrigerados Refrigerated shelf area (m²)	Superficie total exposición (TDA) Total display area (TDA) (m²)	Volumen neto Net volume (Lts.)	Estantes Shelves (Uds.)	Puertas Doors (Uds.)	Potencia frig. Frig. Power HC (W)	Consumo Nominal Nominal power HC (W)	Clase Energética Energy Class	
 HDG1 09 M1	998	2.00	1.15	549	4	2	496 - 1018W	4.55	B	6.944 €
 HDG1 12 M1	1310	2.68	1.50	714	4	2	497 - 1018W	5.4	B	7.009 €
 HDG1 18 M1	1935	4.01	2.24	879	8	3	1018 - 1636W	11.01	C	7.902 €
 HDG3 09 M1	998	2.47	1.17	659	4	2	498 - 1018W	4.55	B	7.063 €
 HDG3 12 M1	1310	3.30	1.52	857	4	2	499 - 1018W	5.4	B	7.127 €
 HDG3 18 M1	1935	4.95	2.29	1055	8	3	1018 - 1636W	11.01	C	8.002 €



HDG1 12 (Perla)

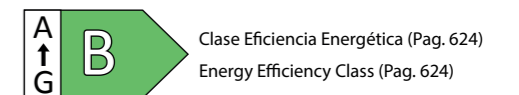

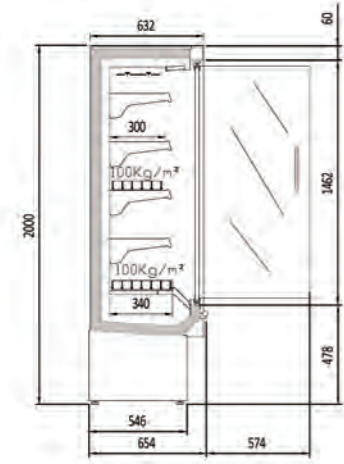

DGo M1-M2

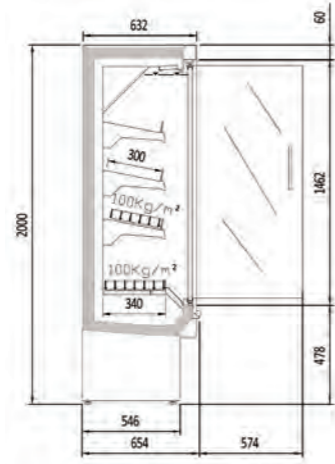

DGo H1



Lateral modelo panorámico LE
Model panoramic side LE



Modelo Model	Largo (con costados) Length (with sides)	Área estantes refrigerados Refrigerated shelf area	Superficie total exposición (TDA) Total display area (TDA)	Volumen neto Net volume	Estantes Shelves	Puertas Doors	Potencia frig. Frig. Power HC	Consumo Nominal Nominal power HC	
	(mm)	(m²)	(m²)	(Lts.)	(Uds.)	(Uds.)	(W)	(W)	
DGo 06 M1-M2	685	1.00	0.73	255	4	1	555	1132	4.033 €
DGo 06 H1	685	0.81	0.72	239	3	1	555	1132	3.991 €
DGo 09 M1-M2	998	1.50	1.11	392	4	2	1192	1494	4.524 €
DGo 09 H1	998	1.21	1.09	368	3	2	1192	1494	4.613 €
DGo 12 M1-M2	1310	2.00	1.46	510	4	2	1192	1508	4.578 €
DGo 12 H1	1310	1.61	1.44	480	3	2	1192	1508	4.667 €
DGo 15 M1-M2	1623	2.50	1.77	668	8	2	1419	1635	5.747 €
DGo 15 H1	1623	2.02	1.75	628	6	2	1419	1635	5.835 €
DGo 18 M1-M2	1935	3.00	2.19	784	8	3	1528	1945	5.888 €
DGo 18 H1	1935	2.42	2.17	737	6	3	1528	1945	6.003 €
DGo 25 M1-M2	2560	4.00	2.90	1020	8	4	2384	2612	7.164 €
DGo 25 H1	2560	3.23	2.88	959	6	4	2384	2612	7.303 €
DGo 31 M1-M2	3185	5.00	3.54	1336	16	4	2838	3377	10.694 €
DGo 31 H1	3185	4.03	3.52	1256	12	4	2838	3377	10.572 €



DGo 15 (Teja)



Clase Eficiencia Energética (Pag. 624)
Energy Efficiency Class (Pag. 624)

OPCIONALES · OPTIONS

Modelo Model	Decoración Frontal Front decor	Total decoración Total decor	Total decoración alto brillo Total decor high gloss	Tope estante metacrilato Methacrylate shelf stopper	Paragolpes tubo inox. Stainless steel bumper	Iluminación LED X nivel de estantes LED Lighting X shelves level	Pre Instalación Remote Unit
DGo 06							
DGo 06	260 €	463 €	613 €	31 €	45 €	40 €	-166 €
DGo 09	271 €	471 €	627 €	36 €	65 €	59 €	-223 €
DGo 12	286 €	479 €	646 €	39 €	83 €	77 €	-275 €
DGo 15	296 €	485 €	659 €	41 €	97 €	82 €	-286 €
DGo 18	317 €	492 €	673 €	57 €	119 €	114 €	-327 €
DGo 25	328 €	499 €	686 €	67 €	151 €	154 €	-530 €
DGo 31	374 €	504 €	738 €	82 €	193 €	191 €	-733 €

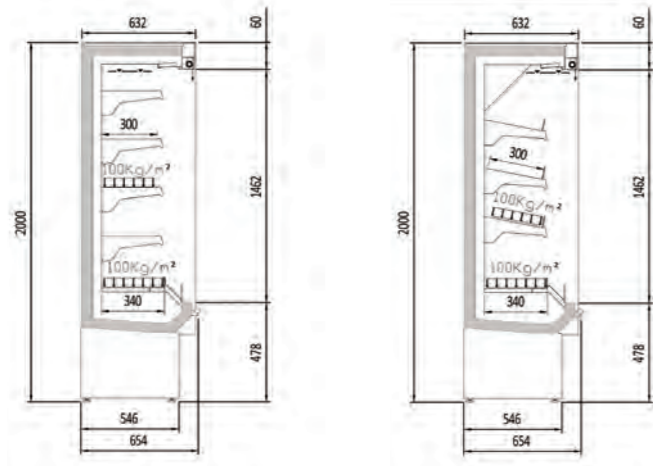

DSo M1-M2

DSo H1







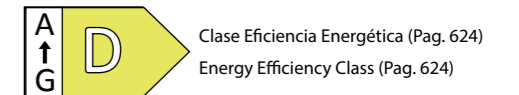

Lateral modelo panorámico LE
Model panoramic side LE





DSo 15 (Gris plomo)



Clase Eficiencia Energética (Pag. 624)
Energy Efficiency Class (Pag. 624)

Modelo Model	Largo (con costados) Length (with sides)	Área estantes refrigerados Refrigerated shelf area	Superficie total exposición (TDA) Total display area (TDA)	Volumen neto Net volume	Estantes Shelves	Puertas Doors	Potencia frig. Frig. Power HC	Consumo Nominal Nominal power HC	
	(mm)	(m²)	(m²)	(Lts.)	(Uds.)	(Uds.)	(W)	(W)	
 DSo 06 M2	685	1.00	0.84	255	4	-	1192	1382	3.138 €
 DSo 06 H1	685	0.81	0.83	239	3	-	1192	1382	3.227 €
 DSo 09 M2	998	1.50	1.27	392	4	-	1528	1713	3.721 €
 DSo 09 H1	998	1.21	1.25	368	3	-	1528	1713	3.810 €
 DSo 12 M2	1310	2.00	1.64	510	4	-	1931	1885	4.151 €
 DSo 12 H1	1310	1.61	1.62	480	3	-	1931	1885	4.240 €
 DSo 15 M2	1623	2.50	2.03	668	8	-	2384	2368	5.120 €
DSo 15 H1	1623	2.02	2.01	628	6	-	2384	2368	5.254 €
DSo 18 M2	1935	3.00	2.50	784	8	-	3056	3026	5.736 €
DSo 18 H1	1935	2.42	2.48	737	6	-	3056	3026	5.854 €
DSo 25 M2	2560	4.00	3.20	1020	8	-	3862	3770	6.371 €
DSo 25 H1	2560	3.23	3.18	959	6	-	3862	3770	6.460 €

OPCIONALES · OPTIONS

Modelo Model	Decoración Frontal Front decor	Total decoración Total decor	Total decoración alto brillo Total decor high gloss	Tope estante metacrilato Methacrylate shelf stopper	Paragolpes tubo inox. Stainless steel bumper	Iluminación LED X nivel de estantes LED Lighting X shelves level	Pre Instalación Remote Unit
DSo 06							
DSo 06	260 €	463 €	613 €	31 €	45 €	40 €	-166 €
DSo 09	271 €	471 €	627 €	36 €	65 €	59 €	-223 €
DSo 12	286 €	479 €	646 €	39 €	83 €	77 €	-275 €
DSo 15	296 €	485 €	659 €	41 €	97 €	82 €	-286 €
DSo 18	317 €	492 €	673 €	57 €	119 €	114 €	-327 €
DSo 25	328 €	499 €	686 €	67 €	151 €	154 €	-530 €

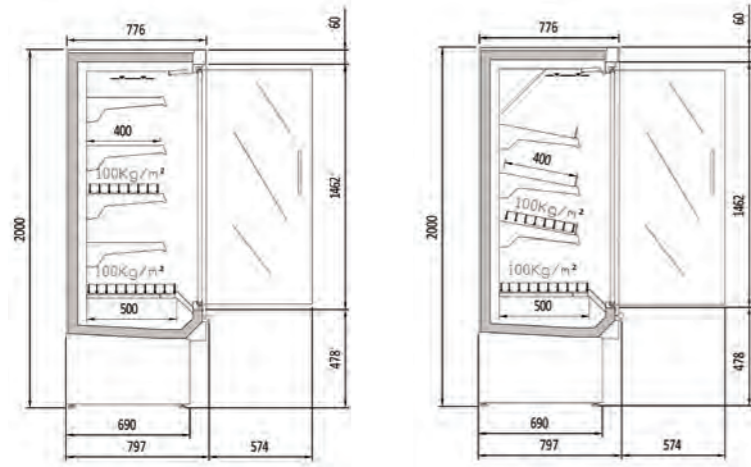

Lateral modelo panorámico LE
Model panoramic side LE

DG1 M1-M2

DG1 H1



Modelo Model	Largo (con costados) Length (with sides)	Área estantes refrigerados Refrigerated shelf area	Superficie total exposición (TDA) Total display area (TDA)	Volumen neto Net volume	Estantes Shelves	Puertas Doors	Potencia frig. Frig. Power HC	Consumo Nominal Nominal power HC	Modelo ABS ABS Model	Modelo LE LE Model
	(mm)	(m²)	(m²)	(Lts.)	(Uds.)	(Uds.)	(W)	(W)		
DG1 06 M1-M2	685	1.34	0.76	357	4	1	555	1132	4.158 €	5.138 €
DG1 06 H1	685	1.08	0.75	336	3	1	555	1132	4.151 €	5.130 €
DG1 09 M1-M2	998	2.00	1.15	549	4	2	1192	1494	4.614 €	5.593 €
DG1 09 H1	998	1.62	1.13	516	3	2	1192	1494	4.658 €	5.637 €
DG1 12 M1-M2	1310	2.68	1.50	714	4	2	1192	1508	4.669 €	5.649 €
DG1 12 H1	1310	2.16	1.48	671	3	2	1192	1508	4.715 €	5.694 €
DG1 15 M1-M2	1623	3.34	1.83	935	8	2	1419	1635	5.836 €	6.816 €
DG1 15 H1	1623	2.70	1.81	879	6	2	1419	1635	5.845 €	6.825 €
DG1 18 M1-M2	1935	4.01	2.24	1098	8	3	1528	1945	6.001 €	6.980 €
DG1 18 H1	1935	3.24	2.22	1032	6	3	1528	1945	6.057 €	7.037 €
DG1 25 M1-M2	2560	5.35	2.94	1428	8	4	2384	2612	7.272 €	8.261 €
DG1 25 H1	2560	4.33	2.92	1342	6	4	2384	2612	7.370 €	8.378 €
DG1 31 M1-M2	3185	6.69	3.60	1870	16	4	2838	3377	10.953 €	11.951 €
DG1 31 H1	3185	5.41	3.58	1758	12	4	2838	3377	10.935 €	11.934 €



DG1 18 MI-M2



Tu elección rápida, en stock, siempre listo
Disponible en decoración exterior color negro
Your quick choice, always in stock, always ready
Available in black exterior finish



Clase Eficiencia Energética (Pag. 624)
Energy Efficiency Class (Pag. 624)

OPCIONALES · OPTIONS

Modelo Model	Decoración Frontal Front decor	Total decoración Total decor	Total decoración alto brillo Total decor high gloss	Tope estante metacrilato Methacrylate shelf stopper	Paragolpes tubo inox. Stainless steel bumper	Iluminación LED X nivel de estantes LED Lighting X shelves level	Pre Instalación Remote Unit
DG1 06							
DG1 06	260 €	463 €	613 €	31 €	45 €	40 €	-166 €
DG1 09	271 €	471 €	627 €	36 €	65 €	59 €	-223 €
DG1 12	286 €	479 €	646 €	39 €	83 €	77 €	-275 €
DG1 15	296 €	485 €	659 €	41 €	97 €	82 €	-286 €
DG1 18	317 €	492 €	673 €	57 €	119 €	114 €	-327 €
DG1 25	328 €	499 €	686 €	67 €	151 €	154 €	-530 €
DG1 31	374 €	504 €	738 €	82 €	193 €	191 €	-733 €

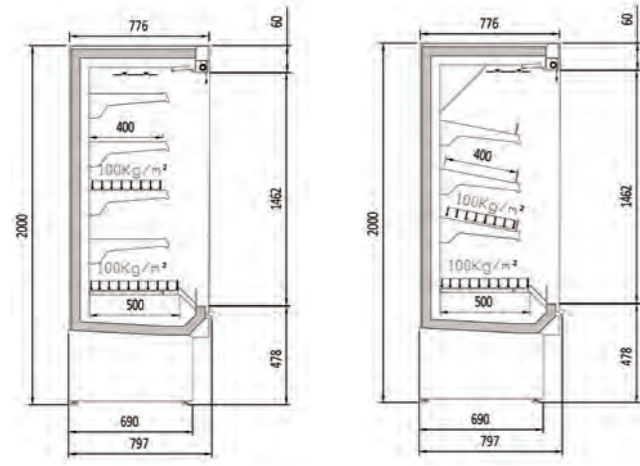

DS1 M1-M2

DS1 H1



Lateral modelo panorámico LE
Model panoramic side LE



DS1 15 (Gris plomo)



Clase Eficiencia Energética (Pag. 624)
Energy Efficiency Class (Pag. 624)

Modelo Model	Largo (con costados) Length (with sides) (mm)	Área estantes refrigerados Refrigerated shelf area TDA (m²)	Superficie total exposición (TDA) Total display area (TDA) (m²)	Volumen neto Net volume (Lts.)	Estantes Shelves (Uds.)	Puertas Doors (Uds.)	Potencia frig. Frig. Power HC (W)	Consumo Nominal Nominal power HC (W)	Modelo ABS ABS Model	Modelo LE LE Model
DS1 06 M2	685	1,34	0,87	357	4	-	1192	1382	3.279 €	4.315 €
DS1 06 H1	685	1,08	0,86	336	3	-	1192	1382	3.289 €	4.325 €
DS1 09 M2	998	2,00	1,32	549	4	-	1528	1713	3.868 €	4.904 €
DS1 09 H1	998	1,62	1,30	516	3	-	1528	1713	3.861 €	4.896 €
DS1 12 M2	1310	2,68	1,72	714	4	-	1931	1885	4.306 €	5.341 €
DS1 12 H1	1310	2,16	1,70	671	3	-	1931	1885	4.317 €	5.352 €
DS1 15 M2	1623	3,34	2,10	935	8	-	2384	2368	5.468 €	6.503 €
DS1 15 H1	1623	2,70	2,08	879	6	-	2384	2368	5.322 €	6.358 €
DS1 18 M2	1935	4,01	2,58	1098	8	-	3056	3026	5.852 €	6.888 €
DS1 18 H1	1935	3,24	2,56	1032	6	-	3056	3026	5.911 €	6.946 €
DS1 25 M2	2560	5,35	3,38	1428	8	-	3862	3770	6.467 €	7.502 €
DS1 25 H1	2560	4,33	3,36	1342	6	-	3862	3770	6.575 €	7.610 €

OPCIONALES · OPTIONS

Modelo Model	Decoración Frontal Front decor	Total decoración Total decor	Total decoración alto brillo Total decor high gloss	Tope estante metacrilato Methacrylate shelf stopper	Paragolpes tubo inox. Stainless steel bumper	Iluminación LED X nivel de estantes LED Lighting X shelves level	Pre Instalación Remote Unit
DS1 06	260 €	463 €	613 €	31 €	45 €	40 €	-166 €
DS1 09	271 €	471 €	627 €	36 €	65 €	59 €	-223 €
DS1 12	286 €	479 €	646 €	39 €	83 €	77 €	-275 €
DS1 15	296 €	485 €	659 €	41 €	97 €	82 €	-286 €
DS1 18	317 €	492 €	673 €	57 €	119 €	114 €	-327 €
DS1 25	328 €	499 €	686 €	67 €	151 €	154 €	-530 €

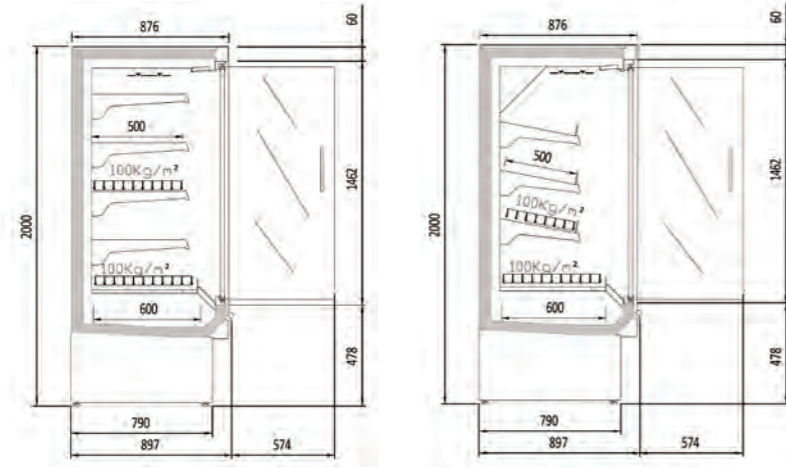

DG3 M1-M2

DG3 H1



Lateral modelo panorámico LE
Model panoramic side LE



DG3 25 MI-M2 (Negro)

MURALES



Modelo Model	Largo (con costados) Length (with sides) (mm)	Área estantes refrigerados Refrigerated shelf area (m²)	Superficie total exposición (TDA) Total display area (TDA) (m²)	Volumen neto Net volume (Lts.)	Estantes Shelves (Uds.)	Puertas Doors (Uds.)	Potencia frig. Frig. Power HC (W)	Consumo Nominal Nominal power HC (W)	Modelo ABS ABS Model	Modelo LE LE Model
DG3 06 M1-M2	685	1,65	0,78	428	4	1	555	1132	4.366 €	5.346 €
DG3 06 H1	685	1,33	0,77	403	3	1	555	1132	4.362 €	5.341 €
DG3 09 M1-M2	998	2,47	1,17	659	4	2	1192	1494	4.716 €	5.695 €
DG3 09 H1	998	2,00	1,15	619	3	2	1192	1494	4.769 €	5.749 €
DG3 12 M1-M2	1310	3,30	1,52	857	4	2	1192	1508	4.771 €	5.751 €
DG3 12 H1	1310	2,66	1,50	805	3	2	1192	1508	4.827 €	5.807 €
DG3 15 M1-M2	1623	4,12	1,88	1122	8	2	1419	1635	5.936 €	6.915 €
DG3 15 H1	1623	3,33	1,86	1055	6	2	1419	1635	5.850 €	6.829 €
DG3 18 M1-M2	1935	4,95	2,29	1317	8	3	1528	1945	6.136 €	7.116 €
DG3 18 H1	1935	4,00	2,27	1238	6	3	1528	1945	6.208 €	7.187 €
DG3 25 M1-M2	2560	6,60	2,99	1714	8	4	2384	2612	7.329 €	8.318 €
DG3 25 H1	2560	5,33	2,97	1611	6	4	2384	2612	7.554 €	8.561 €
DG3 31 M1-M2	3185	8,25	3,71	2244	16	4	2838	3377	11.807 €	12.806 €
DG3 31 H1	3185	6,65	3,69	2110	12	4	2838	3377	11.394 €	12.393 €

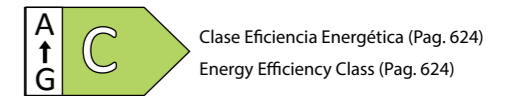

Clase Eficiencia Energética (Pag. 624)
Energy Efficiency Class (Pag. 624)

OPCIONALES · OPTIONS

Modelo Model	Decoración Frontal Front decor	Total decoración Total decor	Total decoración alto brillo Total decor high gloss	Tope estante metacrilato Methacrylate shelf stopper	Paragolpes tubo inox. Stainless steel bumper	Iluminación LED X nivel de estantes LED Lighting X shelves level	Pre Instalación Remote Unit
DG3 06				31 €	45 €	40 €	-166 €
DG3 09	271 €	471 €	627 €	36 €	65 €	59 €	-223 €
DG3 12	286 €	479 €	646 €	39 €	83 €	77 €	-275 €
DG3 15	296 €	485 €	659 €	41 €	97 €	82 €	-286 €
DG3 18	317 €	492 €	673 €	57 €	119 €	114 €	-327 €
DG3 25	328 €	499 €	686 €	67 €	151 €	154 €	-530 €
DG3 31	374 €	504 €	738 €	82 €	193 €	191 €	-733 €

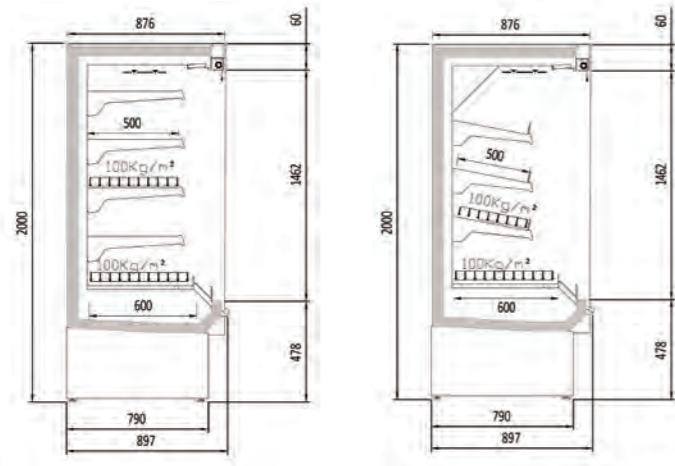

DS3 M1-M2

DS3 H1



Lateral modelo panorámico LE
Model panoramic side LE



DS3 18 H1 (Verde menta)

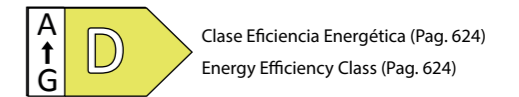

Clase Eficiencia Energética (Pag. 624)
Energy Efficiency Class (Pag. 624)

Modelo Model	Largo (con costados) Length (with sides) (mm)	Área estantes refrigerados Refrigerated shelf area (m²)	Superficie total exposición (TDA) Total display area (TDA) (m²)	Volumen neto Net volume (Lts.)	Estantes Shelves (Uds.)	Puertas Doors (Uds.)	Potencia frig. Frig. Power HC (W)	Consumo Nominal Nominal power HC (W)	Modelo ABS ABS Model	Modelo LE LE Model
DS3 06 M2	685	1,65	0,90	428	4	-	1192	1382	3.363 €	4.399 €
DS3 06 H1	685	1,33	0,89	403	3	-	1192	1382	3.465 €	4.501 €
DS3 09 M2	998	2,47	1,34	659	4	-	1528	1713	3.917 €	4.953 €
DS3 09 H1	998	2,00	1,32	619	3	-	1528	1713	4.037 €	5.073 €
DS3 12 M2	1310	3,30	1,75	857	4	-	1931	1885	4.360 €	5.396 €
DS3 12 H1	1310	2,66	1,73	805	3	-	1931	1885	4.494 €	5.530 €
DS3 15 M2	1623	4,12	2,16	1122	8	-	2384	2368	5.762 €	6.798 €
DS3 15 H1	1623	3,33	2,14	1055	6	-	2384	2368	5.619 €	6.654 €
DS3 18 M2	1935	4,95	2,63	1317	8	-	3056	3026	5.992 €	7.027 €
DS3 18 H1	1935	4,00	2,61	1238	6	-	3056	3026	6.064 €	7.100 €
DS3 25 M2	2560	6,60	3,44	1714	8	-	3862	3770	6.549 €	7.585 €
DS3 25 H1	2560	5,33	3,42	1611	6	-	3862	3770	6.749 €	7.784 €

OPCIONALES · OPTIONS

Modelo Model	Decoración Frontal Front decor	Total decoración Total decor	Total decoración alto brillo Total decor high gloss	Tope estante metacrilato Methacrylate shelf stopper	Paragolpes tubo inox. Stainless steel bumper	Iluminación LED X nivel de estantes LED Lighting X shelves level	Pre Instalación Remote Unit
DS3 06		260 €	463 €	613 €	31 €	40 €	-166 €
DS3 09		271 €	471 €	627 €	36 €	59 €	-223 €
DS3 12		286 €	479 €	646 €	39 €	77 €	-275 €
DS3 15		296 €	485 €	659 €	41 €	82 €	-286 €
DS3 18		317 €	492 €	673 €	57 €	114 €	-327 €
DS3 25		328 €	499 €	686 €	67 €	154 €	-530 €

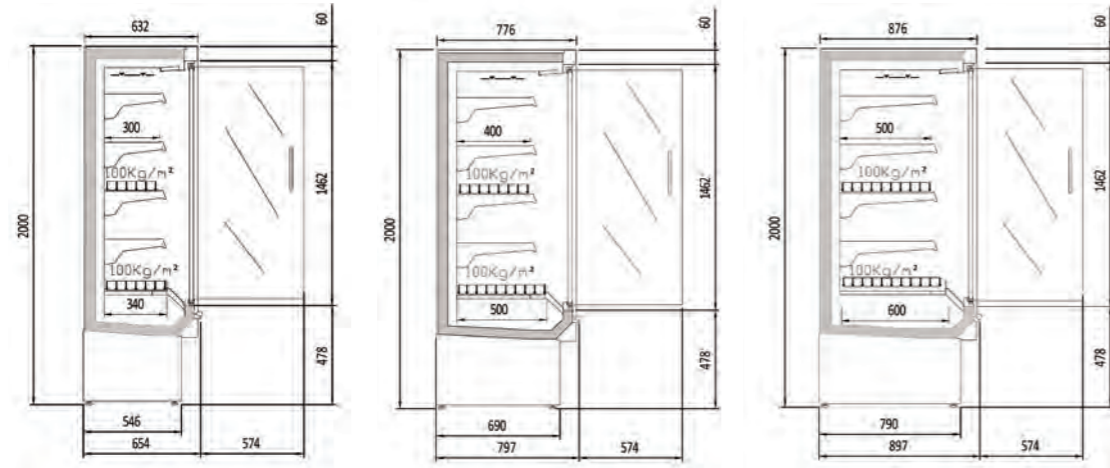

DGo I M1-M2

DG1 I M1-M2

DG3 I M1-M2



DG3 12 M1-M2 (Inox)



Clase Eficiencia Energética (Pag. 624)
Energy Efficiency Class (Pag. 624)

OPCIONALES · OPTIONS

Modelo Model	Tope estante metacrilato Methacrylate shelf stopper	Paragolpes tubo inox. Stainless steel bumper	Iluminación LED X nivel de estantes LED Lighting X shelves Level	Pre Instalación Remote Unit
DG 06 I	31 €	45 €	40 €	-166 €
DG 09 I	36 €	65 €	59 €	-223 €
DG 12 I	39 €	83 €	77 €	-275 €
DG 15 I	41 €	97 €	82 €	-286 €
DG 18 I	57 €	119 €	114 €	-327 €
DG 25 I	67 €	151 €	154 €	-530 €

Modelo Model	Largo (con costados) Length (with sides) (mm)	Área estantes refrigerados Refrigerated shelf area (m²)	Superficie total exposición (TDA) Total display area (TDA) (m²)	Volumen neto Net volume (Lts.)	Estantes Shelves (Uds.)	Puertas Doors (Uds.)	Potencia frig. Frig. Power HC (W)	Consumo Nominal Nominal power HC (W)	Modelo LC LC Model	Modelo LV LV Model
DGo 06 I M1-M2	685	1.00	0.73	255	4	1	555	1132	4.640 €	4.722 €
DG1 06 I M1-M2	685	1.34	0.76	357	4	1	555	1132	4.926 €	5.013 €
DG3 06 I M1-M2	685	1.65	0.78	428	4	1	555	1132	5.087 €	5.132 €
DGo 09 I M1-M2	998	1.50	1.11	392	4	2	1192	1494	5.436 €	5.533 €
DG1 09 I M1-M2	998	2.00	1.15	549	4	2	1192	1494	5.774 €	5.877 €
DG3 09 I M1-M2	998	2.47	1.17	659	4	2	1192	1494	5.975 €	6.029 €
DGo 12 I M1-M2	1310	2.00	1.46	510	4	2	1192	1508	5.962 €	6.067 €
DG1 12 I M1-M2	1310	2.68	1.50	714	4	2	1192	1508	6.335 €	6.447 €
DG3 12 I M1-M2	1310	3.30	1.52	857	4	2	1192	1508	6.617 €	6.676 €
DGo 15 I M1-M2	1623	2.50	1.77	668	8	2	1419	1635	6.733 €	6.852 €
DG1 15 I M1-M2	1623	3.34	1.83	935	8	2	1419	1635	7.510 €	7.643 €
DG3 15 I M1-M2	1623	4.12	1.88	1122	8	2	1419	1635	7.642 €	7.710 €
DGo 18 I M1-M2	1935	3.00	2.19	784	8	3	1528	1945	7.079 €	7.203 €
DG1 18 I M1-M2	1935	4.01	2.24	1098	8	3	1528	1945	8.263 €	8.561 €
DG3 18 I M1-M2	1935	4.95	2.29	1317	8	3	1528	1945	8.596 €	8.673 €
DGo 25 I M1-M2	2560	4.00	2.90	1020	8	4	2384	2612	10.296 €	10.475 €
DG1 25 I M1-M2	2560	5.35	2.94	1428	8	4	2384	2612	10.667 €	10.853 €
DG3 25 I M1-M2	2560	6.60	2.99	1714	8	4	2384	2612	10.859 €	10.954 €

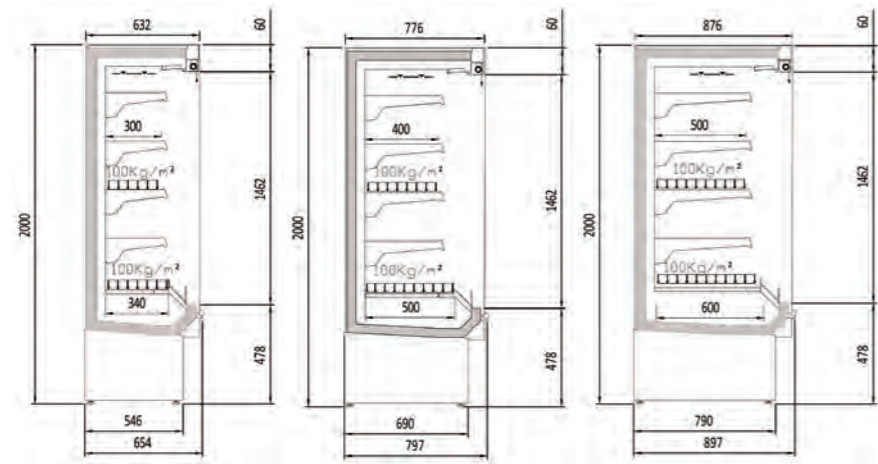

DS0 | M1-M2

DS1 | M1-M2

DS3 | M1-M2

CEDAR DS INOX

docriluc



DS1 25 LV M1-M2 (Inox)

MURALES

Modelo Model	Largo (con costados) Length (with sides) (mm)	Área estantes refrige- rados Refrigerated shelf area (m²)	Superficie total exposición (TDA) Total display area (TDA) (m²)	Volumen neto Net volume (Lts.)	Estan- tes Shelves (Uds.)	Puertas Doors (Uds.)	Potencia frig. Frig. Power HC (W)	Consumo No- minal Nominal power HC (W)	Modelo LC LC Model	Modelo LV LV Model
DS0 06 M2	685	1.00	0.84	255	4	-	1192	1382	3.667 €	3.731 €
DS1 06 M2	685	1.34	0.87	357	4	-	1192	1382	3.979 €	4.048 €
DS3 06 M2	685	1.65	0.90	428	4	-	1192	1382	4.264 €	4.338 €
DS0 09 M2	998	1.50	1.27	392	4	-	1528	1713	4.188 €	4.261 €
DS1 09 M2	998	2.00	1.32	549	4	-	1528	1713	4.544 €	4.623 €
DS3 09 M2	998	2.47	1.34	659	4	-	1528	1713	4.774 €	4.857 €
DS0 12 M2	1310	2.00	1.64	510	4	-	1931	1885	4.896 €	4.981 €
DS1 12 M2	1310	2.68	1.72	714	4	-	1931	1885	5.311 €	5.403 €
DS3 12 M2	1310	3.30	1.75	857	4	-	1931	1885	5.578 €	5.675 €
DS0 15 M2	1623	2.50	2.03	668	8	-	2384	2368	5.798 €	5.899 €
DS1 15 M2	1623	3.34	2.10	935	8	-	2384	2368	6.291 €	6.400 €
DS3 15 M2	1623	4.12	2.16	1122	8	-	2384	2368	6.415 €	6.526 €
DS0 18 M2	1935	3.00	2.50	784	8	-	3056	3026	6.555 €	6.669 €
DS1 18 M2	1935	4.01	2.58	1098	8	-	3056	3026	7.234 €	7.359 €
DS3 18 M2	1935	4.95	2.63	1317	8	-	3056	3026	7.527 €	7.658 €
DS0 25 M2	2560	4.00	3.20	1020	8	-	3862	3770	8.151 €	8.293 €
DS1 25 M2	2560	5.35	3.38	1428	8	-	3862	3770	8.845 €	8.998 €
DS3 25 M2	2560	6.60	3.44	1714	8	-	3862	3770	8.975 €	9.131 €

OPCIONALES · OPTIONS

Modelo Model	Tope estante metacrilato Methacrylate shelf stopper	Paragolpes tubo inox. Stainless steel bumper	Iluminación LED X nivel de estantes LED Ligthing X shelves level	Persiana manual Manual blind	Pre Instalación Remote Unit
DS 06	31 €	45 €	40 €	566 €	-166 €
DS 09	36 €	65 €	59 €	600 €	-223 €
DS 12	39 €	83 €	77 €	650 €	-275 €
DS 15	41 €	97 €	82 €	701 €	-286 €
DS 18	57 €	119 €	114 €	769 €	-327 €
DS 25	67 €	151 €	154 €	-	-530 €

Clase Eficiencia Energética (Pag. 624)
Energy Efficiency Class (Pag. 624)